

BOSA



bosa ★[®]

BOSA

bosa ★[®]

“Le tonalità e le combinazioni cromatiche delle nostre collezioni raccontano l'alternanza delle stagioni, fanno viaggiare la fantasia, ispirano emozioni, creano l'atmosfera quotidiana: gli oggetti che preferite accompagneranno lo scorrere del tempo e i colori che sceglierete li renderanno esclusivamente vostri.”

– Italo Bosa

‘The tones and chromatic combinations of our collections embody the alternating seasons; they let the imagination soar, inspire emotions, and create everyday atmospheres. Your favourite pieces will accompany the passage of time and the colours you choose will make them entirely yours.’

– Italo Bosa

AZIENDA	COMPANY	4
LAVORAZIONI	MANUFACTURING	10
COMPLEMENTI	FURNISHINGS	17
VASI	VASES	24
CENTRITAVOLA	CENTREPIECES	94
COPRIVASI	FLOWER POTS	126
TAVOLI	TABLES	136
CANDELABRI	CANDLE HOLDER	150
OROLOGI	CLOCKS	174
ACCESSORI	ACCESSORIES	190
SCULTURE DECORAZIONI	SCULPTURE DECORATIONS	212
LUCI	LIGHTS	292
DA TAVOLO	TABLE LIGHTS	298
PIANTANE E SOSPENSIONI	FLOOR AND HANGING LIGHTS	316
TAVOLA	TABLEWARE	328
TAZZE	CUPS	334
PIATTI	PLATES	352
BROCCHIE	DECANTERS	366
VASSOI	TRAYS	378
ACCESSORI	ACCESSORIES	388
SUPERFICI	SURFACES	396
INDICI DESIGNER E PRODOTTI	DESIGNERS AND PRODUCTS INDEX	406
COLORI	COLORS	410

In un angolo di campagna veneta reso quasi fiabesco dal gioco irregolare delle colline e dal percorso di vivaci corsi d'acqua, in un paese che riprende nel nome la cima montuosa più nobile ed elevata, Borso Del Grappa, è insediata da un tempo oramai considerevole Bosa, un laboratorio ceramico conosciuto in tutto il mondo. Non è un caso se in quest'area del Veneto pedemontano confluiscono la grande tradizione della ceramica bassanese, lo spirito veneziano di cultura cosmopolita e l'attenzione pionieristica all'innovazione asolana.

È nel 1976 che Italo Bosa avvia la propria produzione ceramica seguendo le antiche tecniche di lavorazione per oggetti realizzati interamente a mano, valorizzati da una ricca palette cromatica, decorati con metalli preziosi – oro, platino, rame – e smalti dalle tonalità esclusive creati dall'azienda. Tecniche precise che sono ancora oggi alla base della produzione di Bosa e che conferiscono agli oggetti unicità, qualità e riconoscibilità.



In a corner of the Venetian countryside, with an enchanting hilly skyline and babbling mountain brooks, there is a town, Borso del Grappa, which echoes the name of its highest and most noble mountaintop, where Bosa, the ceramic industry renowned around the world, chose to settle many years ago. It is no coincidence that the piedmont area of the Veneto region has merged Bassano's great ceramic tradition with Venice's spirit of cosmopolitan culture and Asolo's pioneering attention to innovation.

In 1976 Italo Bosa began his own ceramic production, applying the ancient techniques for making objects entirely by hand, enhanced by a rich palette of colours, decorated with precious metals such as gold, platinum and copper, and enameled in the exclusive shades of colour created by the company. These precision techniques remain the foundation for Bosa's production and ensure that Bosa's objects remain unique, recognizable and of the finest quality.

COMPANY PROFILE

Gli oggetti e i complementi d'arredo in ceramica creati nella maison Bosa, oltre ad esprimere tutta la conoscenza del mestiere artigiano, trasmettono quell'incessante sperimentazione delle possibilità della ceramica che ha tra gli obiettivi la trasformazione di consuetudini formali e funzionali in nuove interpretazioni, nuove funzioni e mondi fantastici, missione che Italo Bosa ha saputo trasferire alle figlie Francesca e Daniela, alla moglie e a tutti i propri collaboratori.

Ciò che contraddistingue Bosa, facendone un'azienda leader nell'ambito della ceramica di design in Italia e nel mondo, è proprio l'aver fatto della ricerca e dell'innovazione i punti di forza dell'azienda, tanto da riuscire a realizzare progetti quasi impossibili per la difficoltà degli stampi e le dimensioni over, che evidenziano la speciale propensione del fondatore a condividere avventure progettuali con i designer, per lo più giovani di provenienze europee, sperimentatori di linguaggi nuovi, che hanno contribuito a definire l'elevato posizionamento del marchio Bosa.

Dall'iniziale collaborazione con Marco Zanuso Jr. e il consolidato rapporto con lo studio Palomba-Serafini, Bosa ha stretto amichevoli relazioni professionali con Constance Guisset, Patricia Urquiola, Nika Zupanc, Ionna Vautrin, Pepa Reverter, Marco Morosini, Manolo Bossi, Gualtiero Sacchi, Sam Baron, Luca Nichetto e un particolare feeling con Jaime Hayon, ideatore di tanti gioiosi universi, e con Elena Salmistraro, dal linguaggio iper-décor. Altrettanto importanti sono da considerare le collaborazioni con aziende leader quali Disney, Minotti, Moroso, B&B Italia, Baccarat e le forniture personalizzate per Ferrari, Escada, DeBeers, Maison Matisse e altri ancora.



The ceramic objects and accessories created by maison Bosa not only express the full range of its crafting expertise, but express its ceaseless experimentation with the potential of ceramic, with the aim of transforming formal and functional conventions into new interpretations, new functions and fantastic worlds, a mission that Bosa has passed on to his daughters Francesca and Daniela, to his wife and to everyone who works with him.

What distinguishes Bosa, and makes it a leader in the field of designer ceramics in Italy and around the world, is its decision to make research and innovation the strong points of the company, thereby creating the know-how required to develop projects that seemed impossible because of the difficulty involved in making oversize objects and moulds, which highlight the special joy the founder takes in sharing the design processes with his mostly young and European designers, who experiment with new languages, and have helped to establish an upscale market position for the Bosa brand.

From the initial collaboration with Marco Zanuso Jr., and the consolidated relationship with the Palomba-Serafini firm, Bosa has developed friendly professional relationships with Constance Guisset, Patricia Urquiola, Nika Zupanc, Ionna Vautrin, Pepa Reverter, Marco Morosini, Manolo Bossi, Gualtiero Sacchi, Sam Baron, Luca Nichetto and a particular understanding with Jaime Hayon, who has invented so many exuberant worlds and Elena Salmistraro and her decorative language. Equally important are its collaborations with leading manufacturers such as Disney, Minotti, Moroso, B&B Italia, Baccarat and its custom-designed contract work for Ferrari, Escada, DeBeers and many others.

↓ The Tournament,
London Design Festival
Trafalgar Square,
London, 2009



Nel 2018 Disney ha scelto Bosa per festeggiare i 90 anni di Topolino, celebrati con numerosi eventi e iniziative in tutto il mondo, e da questa collaborazione speciale è nato un prezioso oggetto da collezione disegnato proprio da Elena Salmistraro, in vendita esclusiva worldwide per 2 anni. Nel 2020 l'azienda presenta il panda Bernardo e il pinguino Dab Penguin che segnano l'inizio di un nuovo progetto dedicato alla natura e alle specie in pericolo: Bosa devolve infatti al WWF una donazione per sostenere azioni in difesa della specie a rischio.

Bosa è attualmente presente in più di 50 nazioni del mondo, non solo per la sua reputazione, l'immagine del marchio e l'identità dei prodotti, ma anche grazie all'attuazione di una politica di marketing puntuale che consente di presidiare diverse nicchie di mercato con un'ampia gamma. La distribuzione così capillarmente risolta si beneficia altresì della presenza sostanziosa di opere di art design nei musei internazionali più prestigiosi, attraverso mostre tematiche, esposizioni temporanee e bookshop che restituiscono all'azienda una continua e benefica visibilità.



→ Mickey Mouse
Forever Young, 2018



In 2018 Disney has chosen Bosa to celebrate the 90th Anniversary of Mickey Mouse, commemorated with a series of events all around the world. This special collaboration gave rise to a precious collector's item designed by Elena Salmistraro, exclusively sold worldwide for 2 years.

In 2020, Bosa presents the panda "Bernardo" and the "Dab Penguin" which mark the beginning of a new project dedicated to nature and endangered species: in fact, Bosa gives a donation to the WWF in support of efforts to protect animals that are at risk of going extinct.

Bosa is currently marketed in over 50 nations around the world, not only thanks to its reputation, brand image and product identity, but also thanks to the implementation of a specific marketing strategy that positions the company in various market niches with an ample range of products. This capillary distribution also benefits from the significant presence of art design pieces in the most prestigious international museums, in thematic exhibitions, temporary shows and bookshops, which ensure the company constant and valuable visibility.

LAVORAZIONI

MANUFACTURING

Tutti gli oggetti della collezione Bosa sono realizzati interamente a mano secondo le antiche tecniche della lavorazione della ceramica. Gli stampi utilizzati sono in gesso per permettere il controllo formale e minuzioso del progetto. Una volta separato il pezzo dallo stampo, l'oggetto viene pulito e rifinito a mano, curandone tutti i minimi dettagli, e quando sarà asciutto potrà essere cotto in forno.

All the objects in the Bosa collection are made entirely by hand using the ancient techniques of ceramic making. The moulds are made out of plaster to allow scrupulous formal control over the project. Once it is removed from the mould, the piece must be cleaned and finished by hand, attending to the smallest of details, and once it is dry it can be fired in the kiln.





Terminata la fase di essiccazione, il pezzo sarà infornato per la prima cottura ottenendo il biscotto. Successivamente si avranno diverse cotture per la vetrificazione dello smalto e per il ritocco delle imperfezioni fino al raggiungimento della massima qualità del prodotto. Gli oggetti decorati con oro, platino o rame, vengono ulteriormente cotti a fuoco dopo la vetrificazione, per fondere il metallo prezioso allo smalto.

When the piece has dried, it will be put in the kiln for the first time and biscuit-fired. It will then be fired several more times to vitrify the glaze and to retouch the imperfections, until the product has achieved the highest possible quality. The objects decorated with gold, platinum or copper, are glaze-fired again after vitrification to fuse the precious metal into the glaze.



Gli smalti, che permettono la vetrificazione dell'oggetto, sono miscelati e composti all'interno del nostro laboratorio ed è per questo che la gamma colori è esclusività di Bosa. Ogni pezzo, dopo la prima cottura, viene immerso in vasche contenenti lo smalto liquido e successivamente sarà ripulito da eventuali gocce o imperfezioni. Lo smalto non viene applicato sulla base dell'oggetto per evitare la sua fusione con le piastre del forno.

The glazes that make it possible to vitrify the object, are mixed and composed in our own workshop, so that Bosa's colour range is exclusive to the company. After the initial firing, each piece is immersed into the tubs containing the liquid glaze; any excess drops or imperfections are later removed. The base of the object is not glazed, to prevent it from fusing to the plates of the kiln.





Le decorazioni sono eseguite a pennello da maestri di massima precisione ed esperienza. I metalli nobili e preziosi quali oro, platino, rame e le loro gamme, applicati con il pennello, fondono assieme allo smalto durante il processo di cottura che, portata a 720°, garantisce l'autenticità del materiale e la sua durata nel tempo.

The decorations are hand-painted by master artist with great precision and experience. Noble and precious metals such as gold, platinum, copper and their ranges, applied with a brush, fuse into the glaze during the firing process, brought to a temperature of 720° to guarantee the authenticity of the materials and its durability over time.

I colori sono il punto di forza di Bosa: molti oggetti si possono personalizzare scegliendo da una gamma di quasi cento tonalità tra smalti lucidi, opachi e metalli preziosi.

Colours are Bosa's strong point: many items can be customised by choosing from almost 100 hues, with shiny, matt and precious metallic finishes.

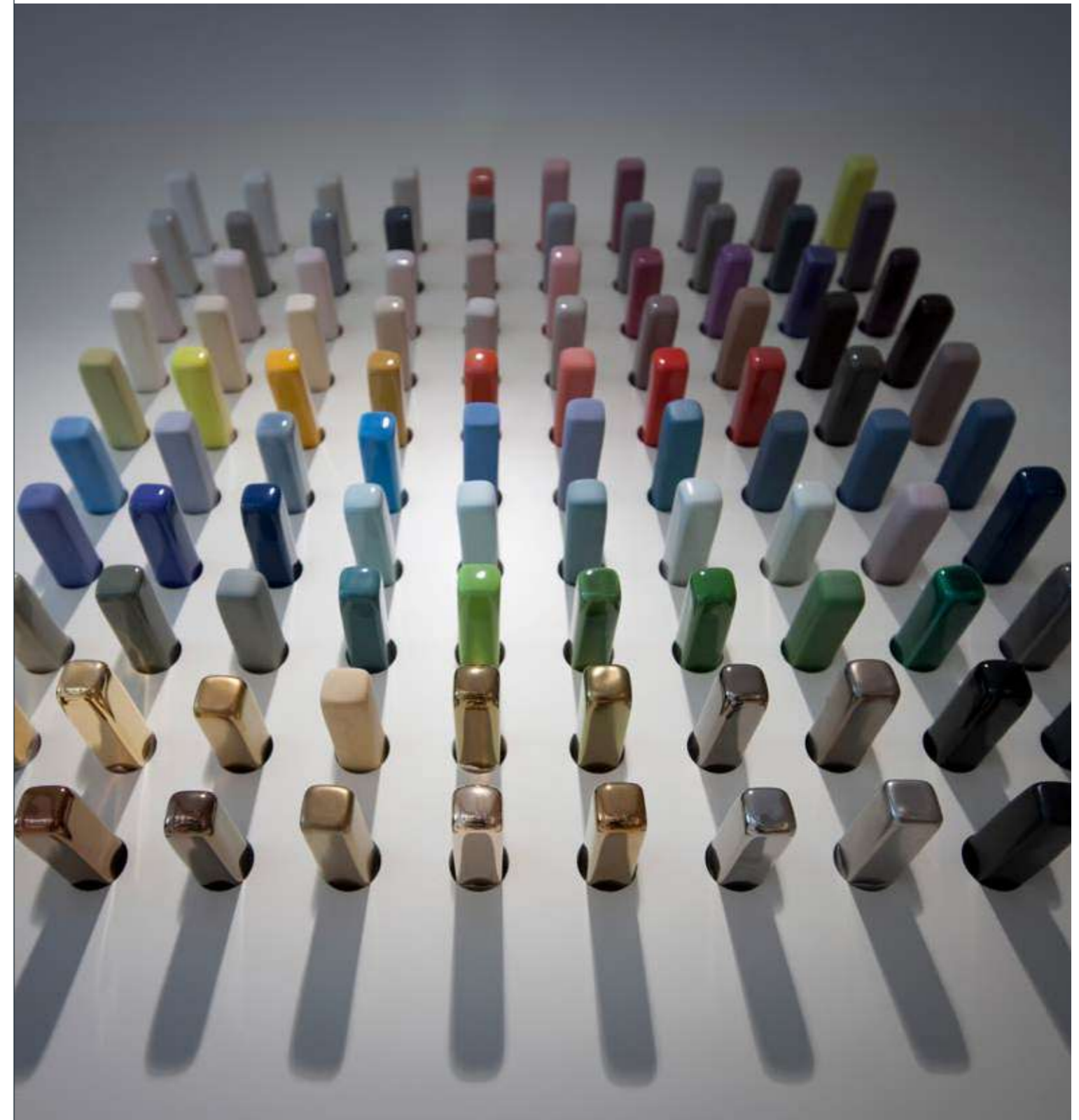

COMPLEMENTI

FURNISHING

VASI	VASES	24
CENTRITAVOLA	CENTREPIECES	94
COPRIVASI	FLOWER POTS	126
TAVOLI	TABLES	136
CANDELABRI	CANDLE HOLDER	150
OROLOGI	CLOCKS	174
ACCESSORI	ACCESSORIES	190
SCULTURE DECORAZIONI	SCULPTURE DECORATIONS	212

VASI VASES	ISOLE Sam Baron —28	...ISSIMA! Sam Baron —30	VENUS Sam Baron —36
PAIRE Francesca Bosa —38	MOVE V-GROOVE ROLLER Francesca Bosa —40	BALL Francesca Bosa —42	BALOO Francesca Bosa —44
BAGUS Italo Bosa —46	GABO Italo Bosa —48	VASICIRCLE Studio Bosa —50	FUSCA Constance Guisset —52
THEATREHAYON Jaime Hayon —56	STRYPY Jaime Hayon —62	CUT Studio Minotti —66	UMBRAVASE Luca Nichetto —70
OOPS Ludovica e Roberto Palomba —72	NADNEDA Shay Frish Peri —74	SISTERS Pepa Reverter —76	PRIMATES Elena Salmistraro —86
POMINA Marco Zanuso jr. —92	CENTRITAVOLA CENTREPIECES	SHELL Francesca Bosa —98	FOGLIABANANO Italo Bosa —100
FOGLIALISCIA Italo Bosa —104	HANDCRAFT Italo Bosa —106	AMASUMPA Marisa Fick Jordaan —108	CUT Studio Minotti —110
TREALI Sachiko Mizoguchi —112	CUP Ludovica e Roberto Palomba —114	HOBART Marco Zanuso jr. —116	MELROSE Marco Zanuso jr. —116
NOAH Nadja Galli Zugaro e G. Grandi —118	HONGKONG Simona Sbordone —120	MIAMI Simona Sbordone —122	TOKYO Simona Sbordone —124

COPRIVASI FLOWERPOTS	...ISSIMA! Sam Baron —130	ROULEAU Francesca Bosa —132	GUDO Francesca Bosa —134
TAVOLI TABLES	JOYA TABLE Jaime Hayon —138	T-TABLE Jaime Hayon —140	BOSSANOVA Pepa Reverter —146
CANDELABRI CANDLE HOLDERS	...ISSIMA! Sam Baron —154	ATOMO Jaime Hayon —158	BUBBLES Jaime Hayon —160
CANFINO Jaime Hayon —162	SPRING Jaime Hayon —164	THEATREHAYON Jaime Hayon —166	PINOCCHIETTO Jaime Hayon —168
6x4 Gualtiero Sacchi —170	LUME Alessandro Zambelli —172	OROLOGI CLOCKS	HORAMUR Jaime Hayon —178
FANTSMIKO Jaime Hayon —180	POSA Marco Zito —182	CELO Marco Zito —184	INFINITY CLOCK Nika Zupanc —186
ACCESSORI CLOCKS	AURA Ciszak-Dalmas —192	SCACCHIERA Studio Bordo —194	DON'T BE TOO SQUARE Francesca Bosa —196
THINBOWL Francesca Bosa —198	PORTAFOTO Italo Bosa —200	HABANOS Gordon Guillaumier —202	KONI Matteo Cibic —204
SWEETSOUVENIR Constance Guisset —206	SECRET LOVE Pepa Reverter —208	MAGIC BALL BOX Nika Zupanc —210	

**SCULTURE
DECORAZIONI
SCULPTURES
DECORATIONS**

**ARIETE,
UNICORNO, TORO**
Sam Baron
-216



VASSILY
Matteo Bianchi
-218



MR. JAMES
Matteo Bianchi
-219



SPHERE
Francesca Bosa
-220



CORALLI
Francesca Bosa
-224



SASSI
Italo Bosa
-228



THE OWLS
Manolo Bossi
-230



TOLO, PILO, CALO
Matteo Cibic
-234

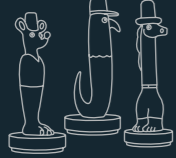

DOMSAI
Matteo Cibic
-236



DOGSAI
Matteo Cibic
-236



UNLOCK
CiriZak
-238



DAB PENGUIN
Vittorio Gennari
-240



MR. CIAO
Vittorio Gennari
-244



HOPEBIRD
Jaime Hayon
-246



CLOWN
Jaime Hayon
-254



MASKHAYON
Jaime Hayon
-256



**DUCKELEFANT
MULTIVASE**
Jaime Hayon
-262



HORSE
Jaime Hayon
-266



COMPAGNOBIRD
Sebastian Herkner
-268



MOMONSTER
Giovanni Motta
-270



PRIMATES MASK
Elena Salmistraro
-274



PRIMATES PLATES
Elena Salmistraro
-276



BERNARDO
Elena Salmistraro
-278



LORICATO, KHEPRI
Elena Salmistraro
-280



MOST ILLUSTRIOUS
Elena Salmistraro
-282



IMOLOSSI
Elena Salmistraro
-284



BEC
Ionna Vautrin
-286



MASCOTTE
Ionna Vautrin
-288

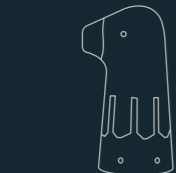

**OH, BABY,
IT IS A WILD WORLD**
Nika Zupanc
-290



Come in un gioioso ballo, i prodotti best seller firmati da Jaime Hayon si divertono a travestirsi con segni forti e toni vivaci: la gestualità del disegno e del colore esprime l'immaginario allegro e fantasioso del designer spagnolo.

Like at some glorious ball, the best selling products designed by Jaime Hayon like to conceal their identities with strong features and vibrant colours: the gestures expressed within the design and colours reveal the upbeat and creative imagination of the Spanish designer.

**COLLEZIONE BAILE
BAILE COLLECTION**
Jaime Hayon

01 HOPEBIRD
-246

02 ATOMO
-158

03 KINGVASE
-56

04 DUCKELEPHANT MULTIVASE
-262

05 MASKHAYON
-256

06 T-TABLE
-140

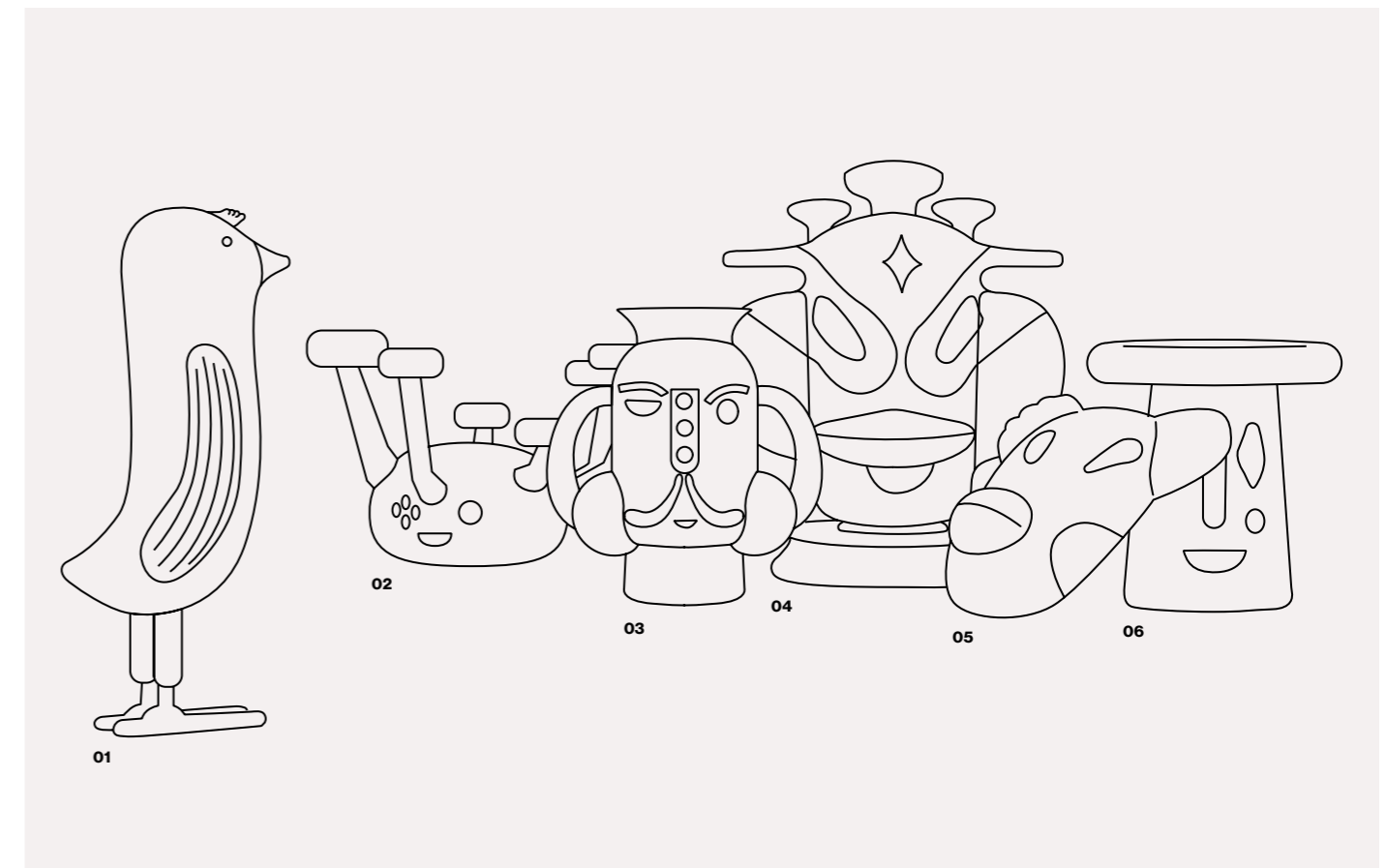



VASES

ISOLE	Sam Baron	28
...ISSIMA!		30
VENUS		36
PAIRE	Francesca Bosa	38
MOOVE		40
V-GROOVE		40
ROLLER		40
BALL		42
BALOO		44
BAGUS	Italo Bosa	46
GABO		48
VASI CIRCLE	Studio Bosa	50
FUSCA	Constance Guisset	52
THEATREHAYON	Jaime Hayon	56
STRIPY		62
CUT	Studio Minotti	66
UMBRAVASE	Luca Nichetto	70
OOPS	Ludovica e Roberto Palomba	72
NADNEDA	Shay Frish Peri	74
SISTERS	Pepa Reverter	76
PRIMATES	Elena Salmistraro	86
POMINA	Marco Zanuso jr.	92





ISOLE
Sam Baron

SB/142	Vaso/Vase	22 × H 50 cm	8.7 × H 19.7 in
SB/143	Vaso/Vase	25 × H 42 cm	9.8 × H 16.5 in
SB/144	Vaso/Vase	39 × H 44 cm	15.4 × H 17.3 in
SB/145	Vaso/Vase	32 × H 28 cm	12.6 × H 11 in
SB/146	Vaso/Vase	35 × H 32 cm	13.8 × H 12.6 in



SB/142 SB/143 SB/144 SB/145 SB/146



...ISSIMA!
SamBaron

SB/147	Vaso/Vase	14 × H 45 cm	5.5 × H 17.7 in
SB/148	Vaso/Vase	19 × H 45 cm	7.5 × H 17.7 in
SB/149	Vaso/Vase	19 × H 45 cm	7.5 × H 17.7 in

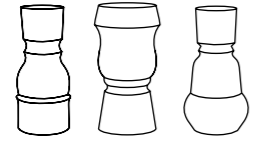

SB/147 SB/148 SB/149



...ISSIMA!
Sam Baron

SB/100	Vaso piccolo/ <i>Small vase</i>	20 × H 44 cm	7.9 × H 17.3 in
SB/101	Vaso grande/ <i>Big vase</i>	29 × H 60 cm	11.4 × H 23.6 in
SB/102	Vaso piccolo/ <i>Small vase</i>	20 × H 32 cm	7.9 × H 12.6 in
SB/103	Vaso grande/ <i>Big vase</i>	29 × H 45 cm	11.4 × H 17.7 in

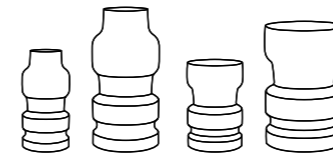

SB/100 SB/101 SB/102 SB/103





...ISSIMA!
Sam Baron

SB/104	Vaso piccolo/Small vase	16 × H34 cm	6.3 × H13.4 in
SB/105	Vaso grande/Big vase	23 × H51 cm	9.1 × H20.1 in



U/1340	Vaso grande/ <i>Big vase</i>	44 × H39 cm	17.3 × H 15.4 in
U/1341	Vaso medio/ <i>Medium vase</i>	28 × H26 cm	11 × H10.2 in
U/1342	Vaso piccolo/ <i>Small vase</i>	16 × H12 cm	6.3 × H 4.7 in



PAIRE
Francesca Bosa

1700 Vaso panciuto/*Paunchy vase* 19 × H 58 cm 7.5 × H 22.8 in
1701 Vaso incavato/*Hollow vase* 20 × H 58 cm 7.9 × H 22.8 in

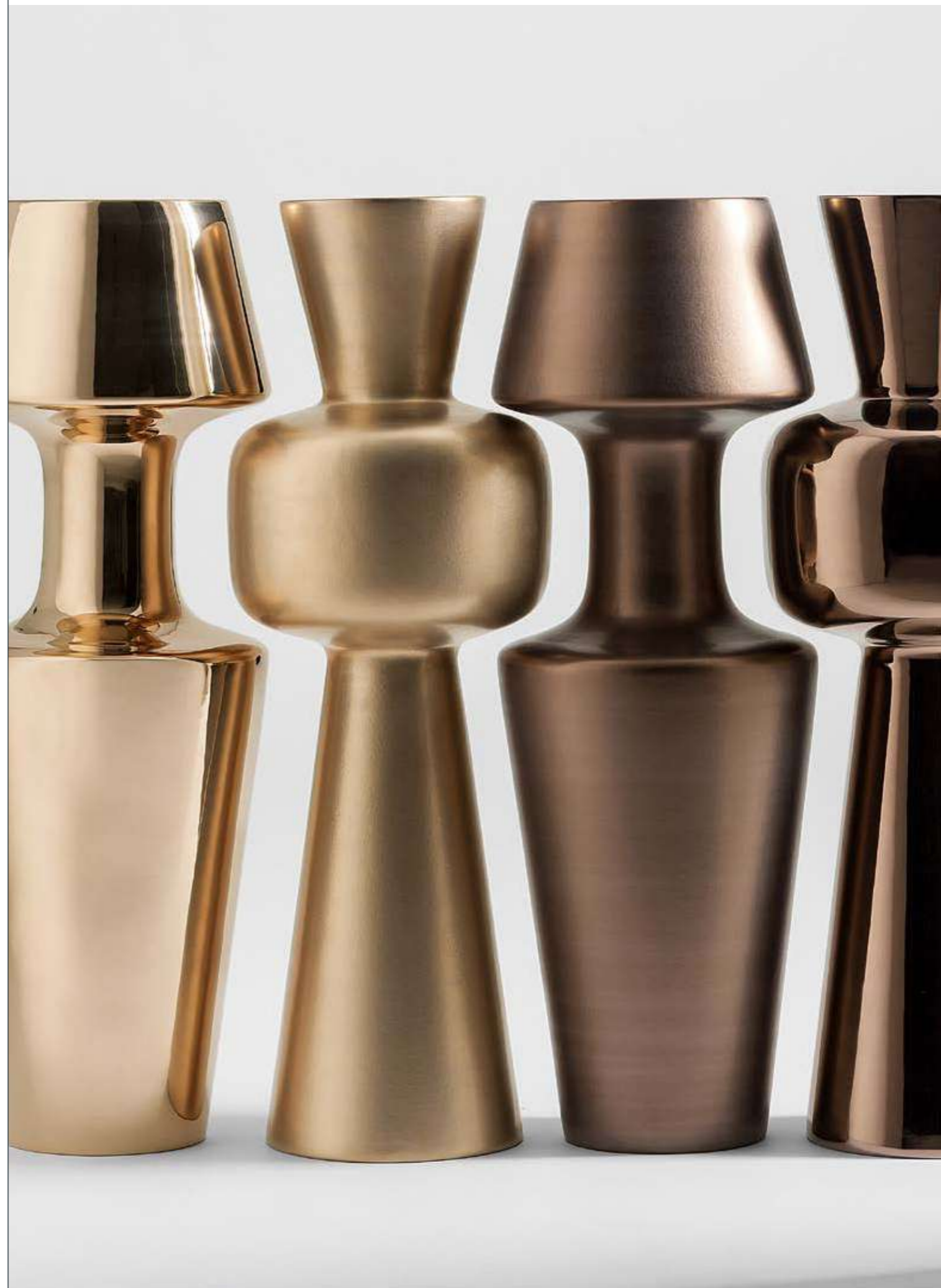

MOVE Francesca Bosa	1102	Vaso rigato grande/ <i>Big vase</i>	18 × H 33 cm	7.1 × H 13 in
	1103	Vaso rigato piccolo/ <i>Small vase</i>	18 × H 17 cm	7.1 × H 6.7 in
V-GROOVE Francesca Bosa	1104	Vaso grande/ <i>Big vase</i>	14 × H 73 cm	5.5 × H 28.7 in
	1105	Vaso medio/ <i>Medium vase</i>	14 × H 59 cm	5.5 × H 23.2 in
	1106	Vaso piccolo/ <i>Small vase</i>	14 × H 35 cm	5.5 × H 13.8 in
ROLLER Francesca Bosa	1100	Vaso liscio grande/ <i>Big smooth vase</i>	18 × H 33 cm	7.1 × H 13 in
	1101	Vaso liscio piccolo/ <i>Small smooth vase</i>	18 × H 17 cm	7.1 × H 6.7 in

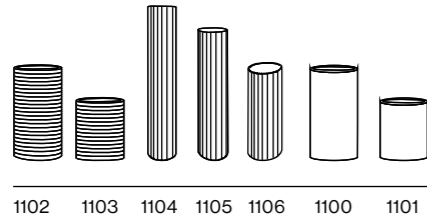

BALL
Francesca Bosa

949	Vaso grande/Big vase	23 × H23 cm	9.1 × H9.1 in
956	Vaso piccolo/Small vase	20 × H20 cm	7.9 × H7.9 in





BAGUS
Italo Bosa

733	Vaso grande/ <i>Big vase</i>	24 × H50 cm	9.4 × H19.7 in
735	Vaso medio/ <i>Medium vase</i>	26 × H32 cm	10.2 × H12.6 in
736	Vaso palla/ <i>Ball vase</i>	30 × H21 cm	11.8 × H8.3 in



GABO
Italo Bosa

737	Vaso alto/ <i>Tall vase</i>	24 × H50 cm	9.4 × H19.7 in
738	Vaso medio/ <i>Medium vase</i>	26 × H32 cm	10.2 × H12.6 in
739	Vaso piccolo/ <i>Small vase</i>	25 × H18 cm	9.8 × H7.1 in



1035	Vaso L/Vase L	40 × H34 cm	15.7 × H13.4 in
1036	Vaso M/Vase M	28 × H24 cm	11 × H9.5 in
1037	Vaso S/Vase S	19 × H18 cm	7.5 × H7.1 in



FUSCA
Constance Guisset

1830	Vaso grande/ <i>Big vase</i>	46 × H 46 cm	18.1 × H 18.1 in
1831	Vaso piccolo/ <i>Small vase</i>	32 × H 33 cm	12.6 × H 13 in





THEATREHAYON
Jaime Hayon

A-H82/G04	Maestro Vase	40 × H50 cm	15.7 × H 19.7 in
A-H79/G04+93	Georgi Tulip Vase	26,5 × H 21 cm	10.4 × H 8.3 in
A-H80/G04+98	Takuya Double Vase	21 × H 32,5 cm	8.3 × H 12.8 in
A-H81/G04	King Vase	34 × H 36 cm	13.4 × H 14.2 in
A-H74/G04+63	Geopablo Vase	30 × H 31 cm	11.8 × H 12.2 in
A-H78/G40	Raki Vase	28 × 20 × H 21,5 cm	11 × 7.9 × H 8.5 in



← Georgi Tulip Vase
→ Maestro Vase
↓ Raki Vase





↑ Geopablo Vase



↑ Takuya Double Vase



↑ King Vase



STRYPY
Jaime Hayon

A-H34	Vaso/Vase	31 × H62 cm	12.2 × H 24.4 in
A-H35	Vaso/Vase	31 × H50 cm	12.2 × H 19.7 in
A-H36	Vaso/Vase	33 × H48 cm	13 × H 18.9 in
A-H37	Vaso/Vase	17 × H35 cm	6.7 × H 13.8 in



A-H34 A-H35 A-H36 A-H37





CUT
StudioMinotti

1600	Vaso grande/ <i>Big vase</i>	24 × H 50 cm	9.4 × H 19.7 in
1601	Vaso medio/ <i>Medium vase</i>	24 × H 36 cm	9.4 × H 14.2 in
1602	Vaso panciuto grande/ <i>Big paunchy vase</i>	32 × H 26 cm	12.6 × H 10.2 in
1603	Vaso panciuto piccolo/ <i>Small paunchy vase</i>	28 × H 21 cm	11 × H 8.3 in







OOPS
Ludovica
e Roberto Palomba

D142	Vaso alto/ <i>Big vase</i>	18 × H 71 cm	7.1 × H 28 in
D143	Vaso medio/ <i>Medium vase</i>	18 × H 38 cm	7.1 × H 15 in
D144	Vaso palla/ <i>Ball vase</i>	47 × H 29 cm	18.5 × H 11.4 in





SISTERS
Pepa Reverter

1770 RO	Louise	26 × 18 × H 37 cm	10.2 × 7 × H 14.6 in
1771 RM	Helen	16 × H 34,5 cm	6.3 × H 13.6 in
1772 RO	Clara	16 × H 37,5 cm	6.3 × H 14.8 in
1773 RO	Sofia	21,5 × H 38,5 cm	8.5 × H 15.2 in
1774 RM	Frida	22 × H 39,5 cm	8.7 × H 15.6 in

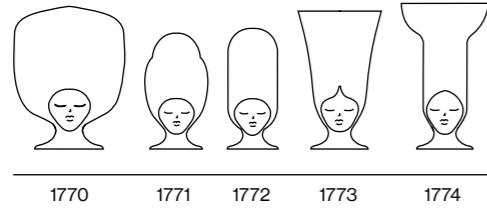

← Louise
← Helen
→ Clara

← Sofia
← Frida



SISTERS
PepaReverter

1770D1 Louise
1771D3R Helen
1772D3 Clara (decorazione verticale/*vertical decoration*)
1772D1 Clara (decorazione orizzontale/*horizontal decoration*)
1773D1 Sofia

26 × 18 × H37 cm 10.2 × 7 × H14.6 in
16 × H34,5 cm 6.3 × H13.6 in
16 × H37,5 cm 6.3 × H14.8 in
16 × H37,5 cm 6.3 × H14.8 in
21,5 × H38,5 cm 8.5 × H15.2 in

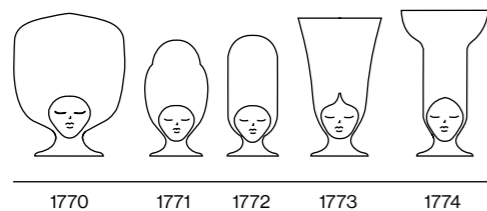

SISTERS
PepaReverter

1770D2 Louise
1771D30 Helen
1772D2 Clara
1773D2 Sofia
1774D2 Frida

26 × 18 × H37 cm 10.2 × 7 × H14.6 in
16 × H34,5 cm 6.3 × H13.6 in
16 × H37,5 cm 6.3 × H14.8 in
21,5 × H38,5 cm 8.5 × H15.2 in
22 × H39,5 cm 8.7 × H15.6 in



SISTERS THAI
Pepa Reverter

1770T	Louise	26 × 18 × H 46 cm	10.2 × 7 × H 18.1 in
1771T	Helen	16 × H 45 cm	6.3 × H 17.7 in
1772T	Clara	16 × H 43 cm	6.3 × H 16.9 in
1773T	Sofia	21,5 × H 38,5 cm	8.5 × H 15.2 in
1774T	Frida	22 × H 39,5 cm	8.7 × H 15.6 in

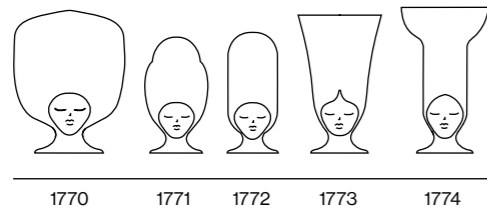

← Louise
← Clara
→ Helen



← Sofia
← Frida





**SISTERS
MADAGASCAR**
Pepa Reverter

1770M	Louise	26 × 18 × H 37 cm	10.2 × 7 × H 14.6 in
1771M	Helen	16 × H 34,5 cm	6.3 × H 13.6 in
1772M	Clara	16 × H 37,5 cm	6.3 × H 14.8 in
1773M	Sofia	21,5 × H 38,5 cm	8.5 × H 15.2 in
1774M	Frida	22 × H 39,5 cm	8.7 × H 15.6 in

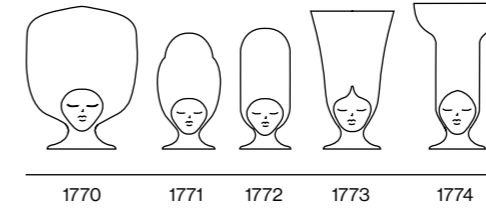

→ Louise
→ Helen
← Frida



→ Clara
→ Sofia



SISTERS CALIFORNIA
Pepa Reverter

1770M2	Louise	26 × 18 × H37 cm	10.2 × 7 × H14.6 in
1771M2	Helen	16 × H34,5 cm	6.3 × H13.6 in
1772M2	Clara	16 × H37,5 cm	6.3 × H14.8 in
1773M2	Sofia	21,5 × H38,5 cm	8.5 × H15.2 in
1774M2	Frida	22 × H39,5 cm	8.7 × H15.6 in

SISTERS IN LOVE
Pepa Reverter

1772L	Clara	16 × H42 cm	6.3 × H16.5 in
-------	-------	-------------	----------------

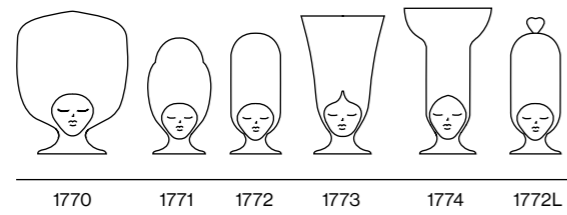



PRIMATES
Elena Salmistraro

A/20	Mandrillus/Vaso/Vase	25 × H 40 cm	9.8 × H 15.7 in
A/21	Brazza/Vaso/Vase	25,5 × H 40 cm	10 × H 15.8 in
A/22	Kandti/Vaso/Vase	26,5 × H 41 cm	10.4 × H 16.1 in

← Mandrillus
→ Kandti
↓ Brazza









CENTREPIECES

CENTRITAVOLA

SHELL	Francesca Bosa	98
FOGLIA BANANO	Italo Bosa	100
FOGLIA LISCIA		104
HANDCRAFT		106
AMASUMPA	Marisa Fick Jordaan	108
CUT	Studio Minotti	110
TREALI	Sachiko Mizoguchi	112
CUP	Ludovica e Roberto Palomba	114
HOBART	Marco Zanuso jr.	116
MELROSE		116
NOAH	Nadja Galli Zugaro e G. Grandi	118
HONG KONG	Simona Sbordone	120
MIAMI		122
TOKYO		124





FOGLIA BANANO
Italo Bosa

900	Foglia XL/XL leaf	70 × 27 × H 5 cm	27.6 × 10.6 × H 2 in
901	Foglia L/L leaf	61 × 22 × H 4 cm	24 × 8.7 × H 1.6 in
904	Foglia M/M leaf	45 × 18 × H 4 cm	17.7 × 7.1 × H 1.6 in
905	Foglia S/S leaf	26 × 10 × H 2 cm	10.2 × 3.9 × H 0.8 in









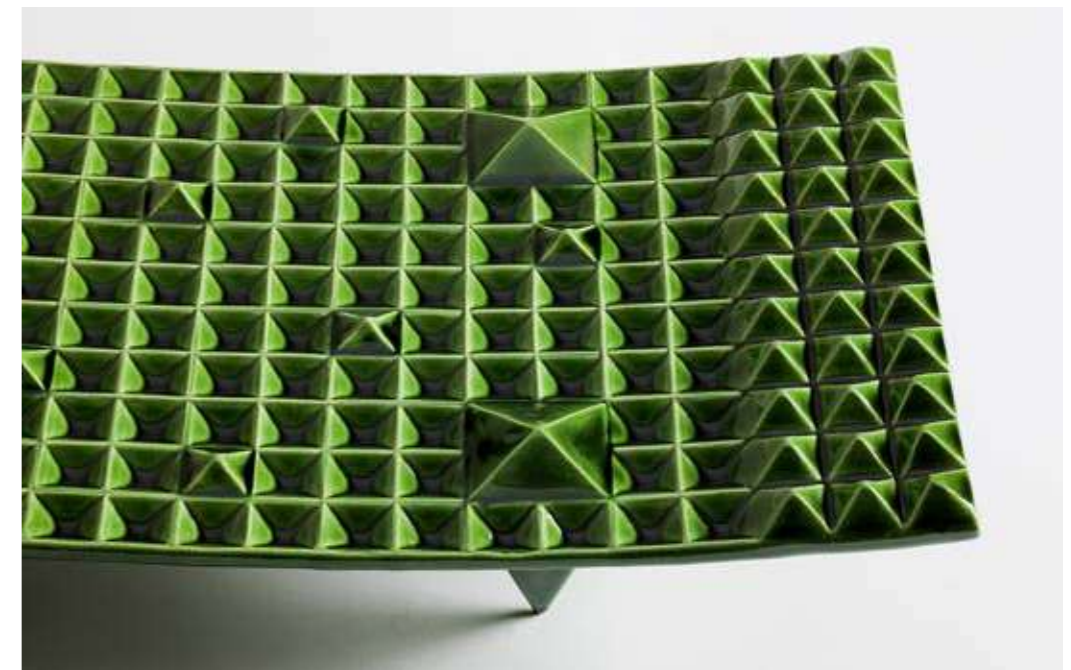



CUT
Studio Minotti

1604	Centrotavola grande/ <i>Big centrepiece</i>	40 × H10 cm	15.7 × H3.9 in
1605	Centrotavola piccolo/ <i>Small centrepiece</i>	30 × H8 cm	11.8 × H3.1 in





CUP
Ludovica
e Roberto Palomba

D134	Ciotola XL/XL bowl	37 × H 25 cm	14.5 × H 9.8 in
D135	Ciotola L/L bowl	26 × H 18 cm	10.2 × H 7.1 in
D122	Ciotola M/M bowl	14 × H 9 cm	5.5 × H 3.5 in
D123	Ciotola S/S bowl	11 × H 7 cm	4.3 × H 2.8 in



HOBART
Marco Zanuso jr.

ZM/016 Centrotavola/*Centrepiece* 52 × H13 cm 20.5 × H5.1 in

MELROSE
Marco Zanuso jr.

ZM/003 Centrotavola grande/*Big centrepiece* 39 × H 16 cm 15.4 × H 6.3 in
ZM/004 Centrotavola medium/*Medium centrepiece* 31 × H 16 cm 12.2 × H 6.3 in
ZM/002 Centrotavola piccolo/*Small centrepiece* 20 × H 21 cm 7.9 × H 8.3 in

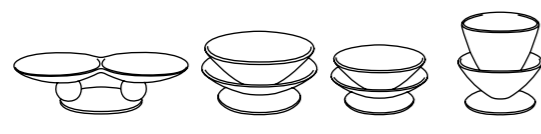

ZM/016

ZM/003

ZM/004

ZM/002



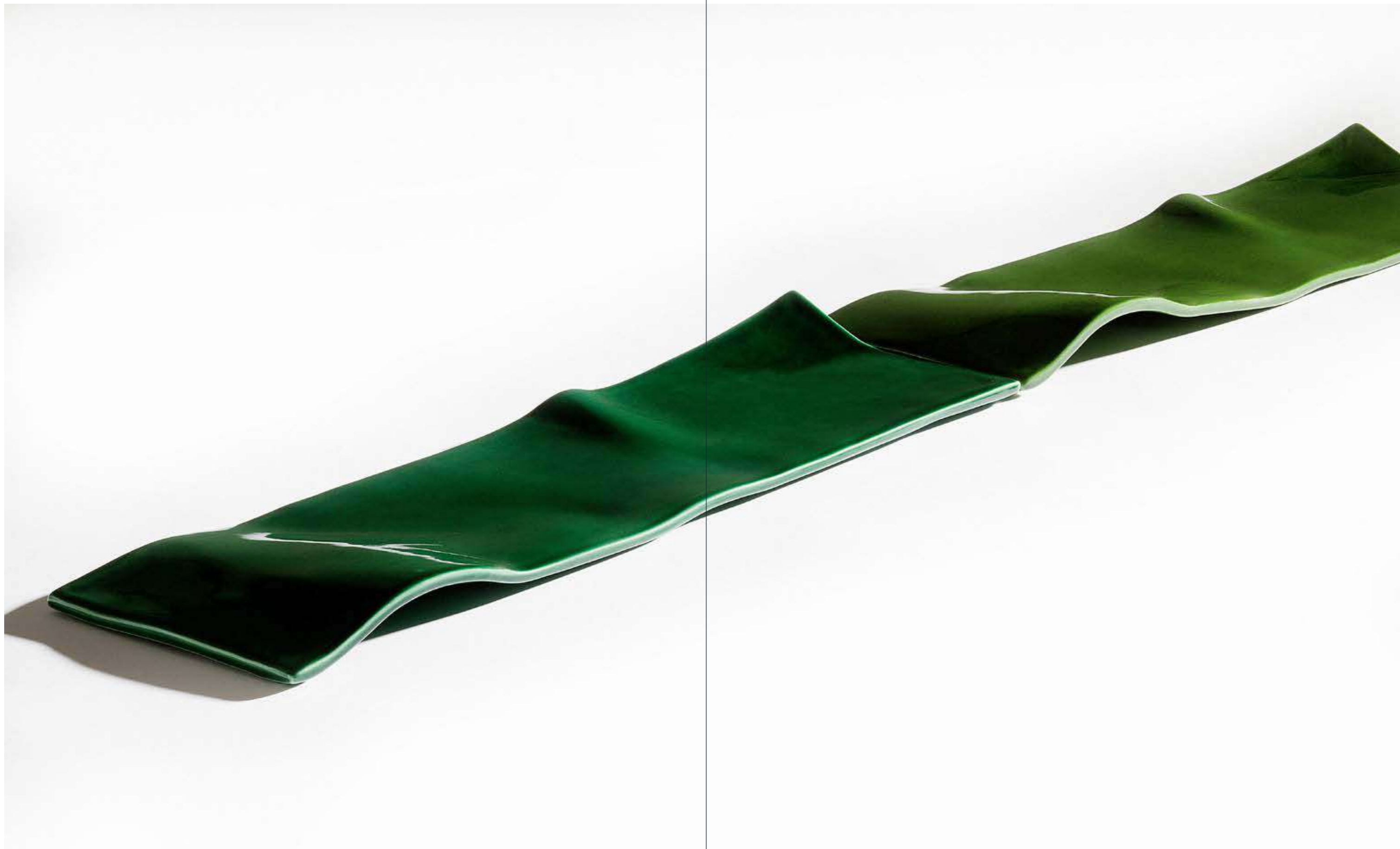





MIAMI
Simona Sbordone

M/MIA1	Centrotavola/Centrepiece	15 × 30 × H 4 cm	5.9 × 11.8 × H 1.6 in
M/MIA2	Centrotavola/Centrepiece	20 × 20 × H 4 cm	7.9 × 7.9 × H 1.6 in
M/MIA3	Centrotavola/Centrepiece	10 × 10 × H 4 cm	3.9 × 3.9 × H 1.6 in

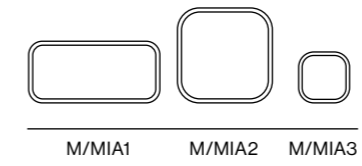



FLOWER POTS

COPRIVASI

...ISSIMA!	Sam Baron	130
ROULEAU GUDO	Francesca Bosa	132 134







GUIDO
Francesca Bosa

1772 Coprivaso/Flowerpot 37 × H26 cm 14.6 × H10.2 in



TABLES

JOYA TABLE	Jaime Hayon	138
T-TABLE		140
BOSSA NOVA	Pepa Reverter	146

TAVOLI



JOYA TABLE
Jaime Hayon

A-H42 Tavolo/Table 48 × H37,5 cm 18.9 × H 14.8 in



T-TABLE
T-TABLE MAXI
T-TABLE TALL
Jaime Hayon

A-H41	Piccolo tavolo/ <i>Little table</i>	31 × H 32 cm	12.2 × H 12.6 in
A-H53	Grande tavolo/ <i>Big table</i>	47 × H 26 cm	18.5 × H 10.2 in
A-H64	Tavolo alto/ <i>Tall Table</i>	41 × H 46 cm	16.1 × H 18.1 in







1903/G1	Gilberto Table black and white	36 × H 62 cm	14.2 × H 24.4 in
1904/G1	Vinicius Table black and white	41 × H 50 cm	16.1 × H 19.7 in
1905/G1	Regina Table black and white	26 × H 40 cm	10.2 × H 15.7 in

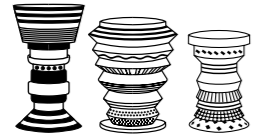

Gilberto Vinicius Regina





BOSSA NOVA
Pepa Reverter

1903/G2	Gilberto Table colors	36 × H 62 cm	14.2 × H 24.4 in
1904/G2	Vinicius Table colors	41 × H 50 cm	16.1 × H 19.7 in
1905/G2	Regina Table colors	26 × H 40 cm	10.2 × H 15.7 in



CANDLE HOLDERS

CANDELABRI

...ISSIMA!	Sam Baron	154
...ISSIMA3!		156
ATOMO	Jaime Hayon	158
BUBBLES		160
CANFINO		162
SPRING		164
THEATREHAYON		166
PINOCCHIETTO		168
6 × 4	Gualtiero Sacchi	170
LUME	Alessandro Zambelli	172



SB/111	Portacandele/Candle holder	15 × H 25 cm	5.9 × H 9.8 in
SB/112	Diffusore di essenze/Essence diffuser	10,5 × H 35 cm	4.1 × H 13.8 in
SB/113	Diffusore di essenze/Essence diffuser	11 × H 40 cm	4.3 × H 15.7 in
SB/114	Diffusore di essenze/Essence diffuser	13 × H 44 cm	5.1 × H 17.3 in

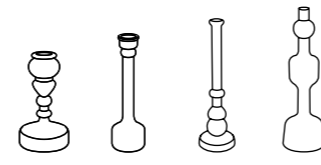

SB/111 SB/112 SB/113 SB/114



...ISSIMA3!
Sam Baron

SB/129	Vaso portacandele/ <i>Candle holder vase</i>	10 × H 35 cm	3.9 × H 13.8 in
SB/130	Vaso portacandele/ <i>Candle holder vase</i>	10 × H 27 cm	3.9 × H 10.6 in
SB/131	Vaso portacandele/ <i>Candle holder vase</i>	7,5 × H 20 cm	3 × H 7.9 in



...ISSIMA!
Sam Baron

SB/109	Portacandele/ <i>Candle holder</i>	16 × H 38 cm	6.3 × H 15 in
SB/110	Portacandele/ <i>Candle holder</i>	10 × H 38 cm	3.9 × H 15 in

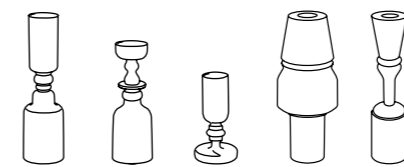

SB/129 SB/130 SB/131 SB/109 SB/110



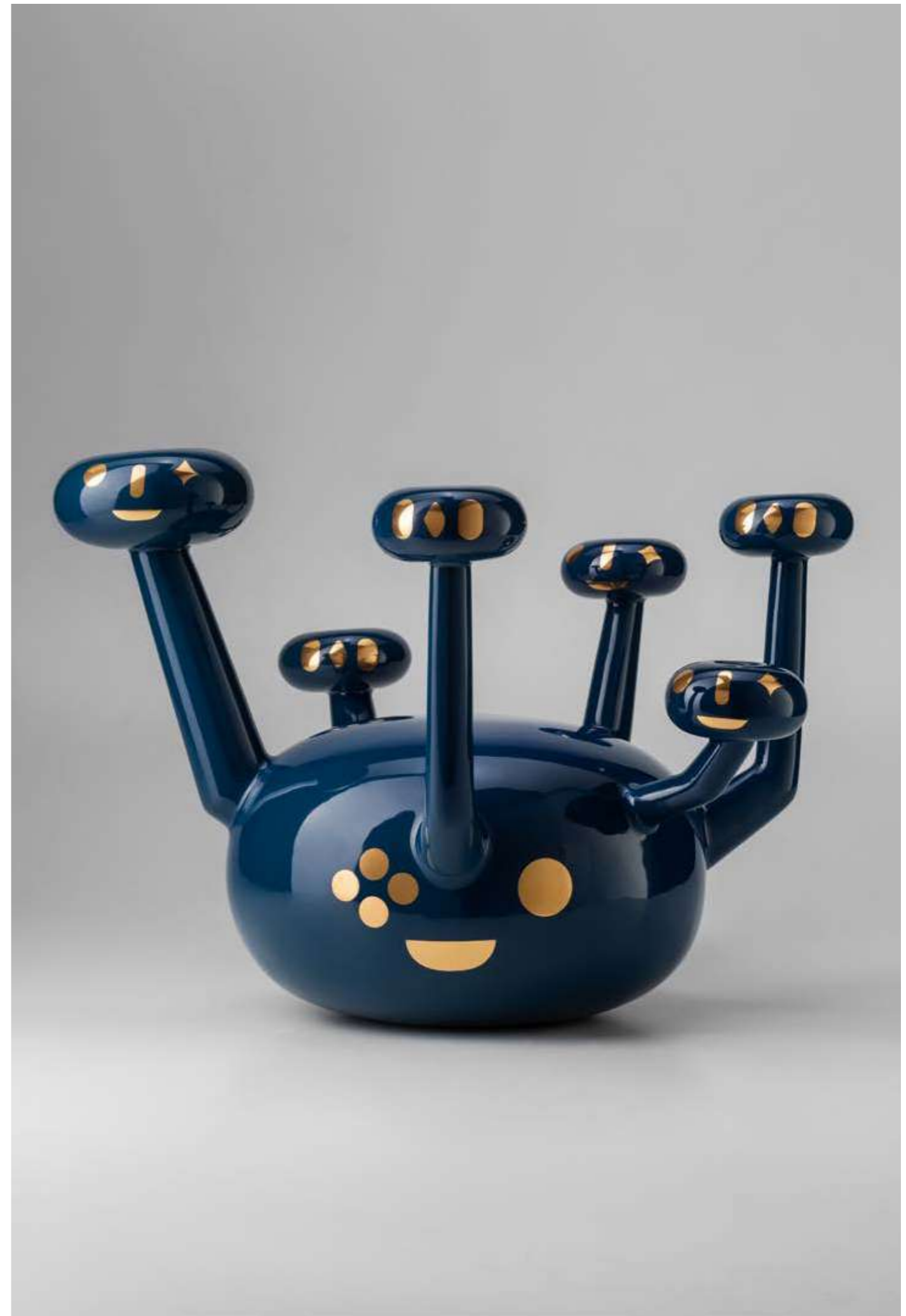



BUBBLES
Jaime Hayon

A-H11 Portacandele/Candle holder 21×H37 cm 8.3×H14.6 in





CANFINO
Jaime Hayon

A-H12 Portacandele/Candle holder 14 × H30 cm 5.5 × H11.8 in





A-H75/G23	Blue Pablo/Porta candele/Candle holder	10 × H 9 cm	3.9 × H 3.5 in
A-H76/G07	Georgio Cool Hat/Porta candele/Candle holder	12 × H 14 cm	4.7 × H 5.5 in
A-H82/G04	Gabu Mall/Porta candele/Candle holder	7 × H 10 cm	2.8 × H 3.9 in



← Gabu Mall
→ Georgio Cool Hat
↓ Blue Pablo





PINOCCHIETTO
Jaime Hayon

A-H54 Portacandela/Candle holder 9 × 6 × H10 cm 3.5 × 2.3 × H3.9 in







CLOCKS

OROLOGI

HORAMUR FANTASMIKO	Jaime Hayon	178 180
POSA CELO	Marco Zito	182 184
INFINITY CLOCK	Nika Zupanc	186

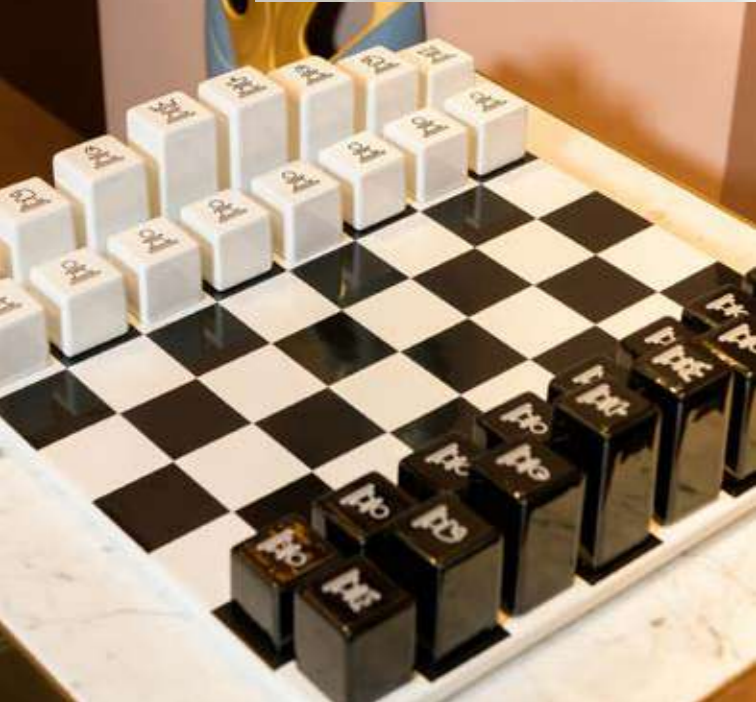

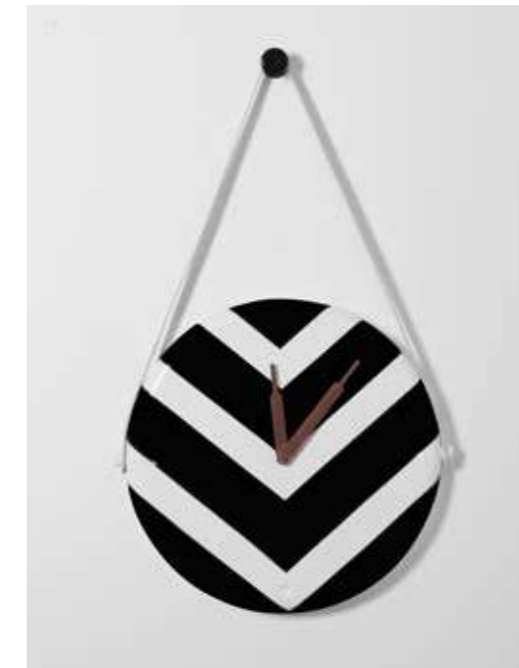
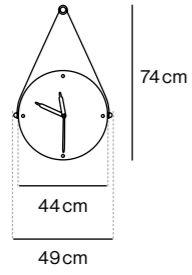



FANTSMIKO
Jaime Hayon

A-H38 Orologio da tavolo/*Table clock* 26 × 15,5 × H 30 cm 10.2 × 6.1 × H 11.8 in

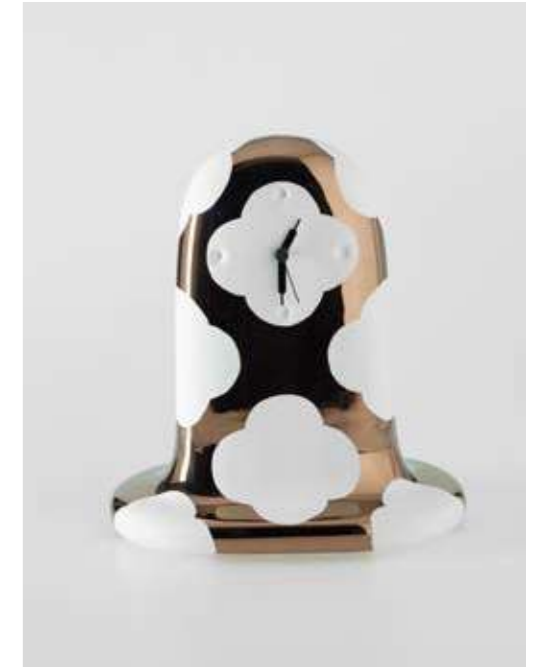









ACCESSORIES

ACCESSORI

AURA	Ciszak-Dalmas	192
SCACCHIERA	Studio Bordò	194
DON'T BE TOO SQUARE THIN BOWL	Francesca Bosa	196 198
PORTAFOTO	Italo Bosa	200
HABANOS	Gordon Guillaumier	202
KONI	Matteo Cibic	204
SWEET SOUVENIR	Costance Guisset	206
SECRET LOVE	Pepa Reverter	208
MAGIC BALL BOX	Nika Zupanc	210



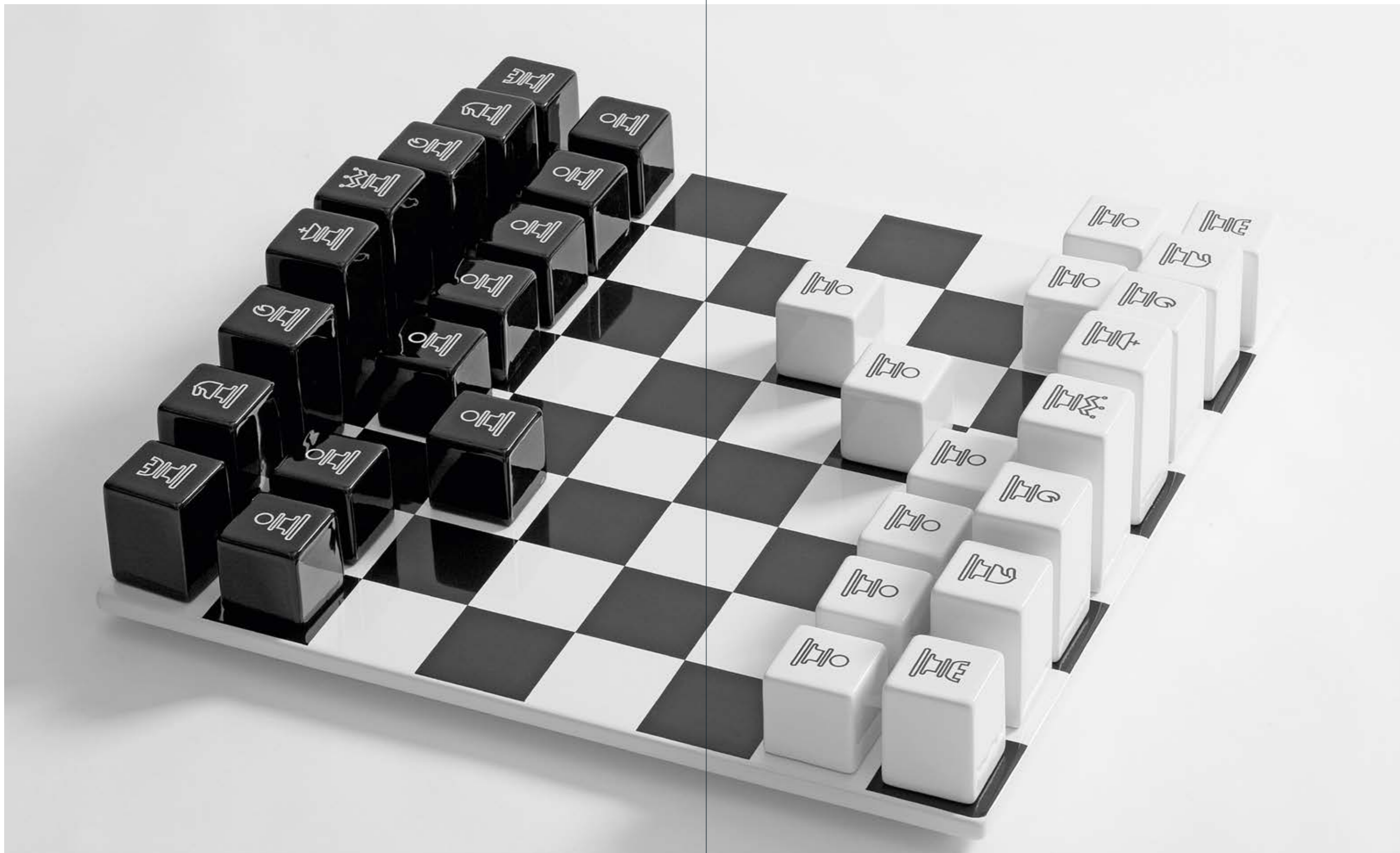

**DON'T BETOO
SQUARE**

Francesca Bosa

1065	Scatola grande/ <i>Big box</i>	33 × 33 × H5 cm	13 × 13 × H2 in
1066	Scatola media/ <i>Medium box</i>	20 × 20 × H5 cm	7.9 × 7.9 × H2 in
1067	Scatola piccola/ <i>Small box</i>	13 × 13 × H5 cm	5.1 × 5.1 × H2 in
1068	Scatola rettangolare/ <i>Rectangular box</i>	33 × 13 × H5 cm	13 × 5.1 × H2 in
1064	Posacenere/ <i>Ashtray</i>	19 × 19 × H7 cm	7.5 × 7.5 × H2.8 in



THINBOWL
Francesca Bosa

1020	Ciotola XL/XL bowl	22 × H 13 cm	8.6 × H 5.1 in
1021	Ciotola L/L bowl	16 × H 10 cm	6.3 × H 3.9 in
1022	Ciotola M/M bowl	22 × H 5 cm	8.6 × H 1.9 in
1023	Ciotola S/S bowl	16 × H 4 cm	6.3 × H 1.6 in



PORTAFOTO
ItaloBosa

1060	Portafoto grande – liscio/ <i>Big photo frame – smooth</i>	38 × H 32 cm	15 × H 12.6 in
1061	Portafoto medio – liscio/ <i>Medium photo frame – smooth</i>	28 × H 22 cm	11 × H 8.7 in
1062	Portafoto piccolo – liscio/ <i>Small photo frame – smooth</i>	22 × H 16 cm	8.7 × H 6.3 in







KONI
Matteo Cibic

1800 Ciotola e cappello/*Cap and bowl* 7,5 × H3,7 cm 2.9 × H1.4 in
Ciotoline impilabili/*Bowl stackable* 7,5 × H13 cm 2.9 × H5.1in





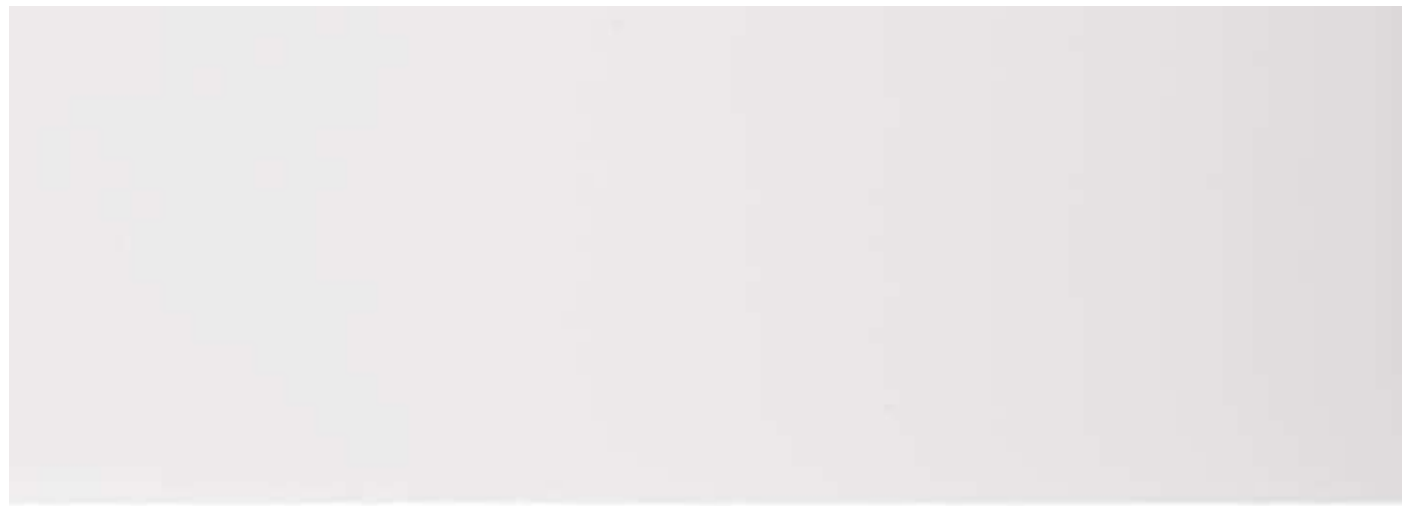

SECRET LOVE
PepaReverter

1804 Scatola/Box container 10×9×H10 cm 3.9×3.5×H3.9 in





SCULPTURES DECORATIONS

SCULTURE DECORAZIONI

ARIETE, UNICORNO, TORO	Sam Baron	216
VASSILY MR. JAMES	Matteo Bianchi	218 218
SPHERE CORALLI	Francesca Bosa	220 224
SASSI	Italo Bosa	228
THE OWLS	Manolo Bossi	230
TOLO, PILO, CALO DOGSAI DOMSAI	Matteo Cibic	234 236 236
UNLOCK	CtrlZak	238
DAB PENGUIN MR. CIAO	Vittorio Gennari	240 244
HOPEBIRD CLOWN MASKHAYON DUCK ELEFANT MULTIVASE HORSE	Jaime Hayon	246 254 256 262 266
COMPAGNO BIRD	Sebastian Herkner	268
MOMONSTER	Giovanni Motta	270
PRIMATES PRIMATES PLATES BERNARDO LORICATO, KHEPRI MOST LLUSTRIOUS IMOLOSSI	Elena Salmistraro	274 276 278 280 282 284
BEC MASCOTTE	Ionna Vautrin	286 288
OH, BABY, IT IS A WILD WORLD	Nika Zupanc	290



A/05	Contenitore unicorno/ <i>Unicorn Container</i>	24 × H 52 cm	9.4 × H 20.5 in
A/06	Contenitore ariete/ <i>Ram Container</i>	21 × H 33 cm	8.3 × H 13 in
A/07	Contenitore toro/ <i>Bull Container</i>	28 × H 37 cm	11 × H 14.6 in



VASSILY
Matteo Bianchi

1845	Vaso scultura/ <i>Sculpture vase</i>	16 × H 37 cm	6.3 × H 14.6 in
1846	Vaso scultura/ <i>Sculpture vase</i>	20 × H 29 cm	7.9 × H 11.4 in
1847	Vaso scultura/ <i>Sculpture vase</i>	26 × H 24 cm	10.2 × H 19.5 in



MR.JAMES
Matteo Bianchi

1842	Scultura-contenitore/ <i>Sculpture-Container</i>	21 × H 27 cm	8.3 × H 10.6 in
1841	Scultura/ <i>Sculpture</i>	14 × H 33 cm	5.5 × H 5.1 in
1840	Scultura/ <i>Sculpture</i>	10 × H 40 cm	3.9 × H 15.8 in
1843	Scultura/ <i>Sculpture</i>	7,5 × H 16 cm	3 × H 6.3 in



SPHERE
Francesca Bosa

1255	Sfera XL/XL sphere	23 × H 22 cm	9.1 × H 8.7 in
1256	Sfera L/L sphere	20 × H 19 cm	7.9 × H 7.5 in
1010	Sfera M/M sphere	16 × H 15 cm	6.3 × H 5.9 in
1011	Sfera S/S sphere	10 × H 9 cm	3.9 × H 3.5 in

Decoration Edward Van Vliet





CORALLI
Francesca Bosa

1007	Corallo singolo/ <i>Single coral</i>	30 × H52 cm	11.8 × H20.5 in
1017	Base grande/ <i>Coral base</i>	12 × 12 × H10 cm	4.7 × 4.7 × H3.9 in
1008	Corallo piccolo/ <i>Small coral</i>	12 × H9 cm	4.7 × H3.5 in
1254	Base sasso per corallo piccolo/ <i>Stone base for small coral</i>	13 × 7 × H3 cm	5.1 × 2.8 × H1.2 in





1000	Sasso XXL/XXL stone	24 × H19 cm	9.4 × H7.5 in
1001	Sasso XL/XL stone	17 × H14 cm	6.7 × H5.5 in
1002	Sasso L/L stone	13 × H8 cm	5.1 × H3.1 in
1003	Sasso M/M stone	13 × H3 cm	5.1 × H1.2 in



THE OWLS
Manolo Bossi

1785	Gufo/Owl	14 × H 36 cm	5.5 × H 14.2 in
1786	Barbagianni/Barn owl	13 × H 26 cm	5.1 × H 10.2 in
1787	Civetta nana/Screech owl	11 × H 15 cm	4.3 × H 5.9 in





A/08	Pappagallo Pesce/Parrot Fish	9 × H22 cm	3.5 × H8.7 in
A/09	Topo Orso/Mouse Bear	9 × H24 cm	3.5 × H9.4 in
A/10	Cavallo Uomo/Horse Man	9 × H26 cm	3.5 × H10.2 in



DOGSAI
Matteo Cibic

DOM/DOG Scultura/Sculpture vase
DOM/DOG1 Orecchie a punta/Pointy Ears
DOM/DOG2 Orecchie tonde/Round Ears

10 × H20 cm 3.9 × H7.9 in

DOMSAI
Matteo Cibic

Dim Sculture – Mini vasi/Sculptures – mini vases
Dom-Dam Sculture – Mini vasi/Sculptures – mini vases
Domlite Sculture – Mini vasi/Sculptures – mini vases
Laurel Sculture – Mini vasi/Sculptures – mini vases
Hardy Sculture – Mini vasi/Sculptures – mini vases
Domsai L Sculture – Mini vasi/Sculptures – mini vases

10 × H22 cm 3.9 × H8.7 in
10 × H26 cm 3.9 × H10.2 in
10 × H24 cm 3.9 × H9.4 in
10 × H28 cm 3.9 × H11 in
10 × H22 cm 3.9 × H8.7 in
16 × H42 cm 6.3 × H16.5 in

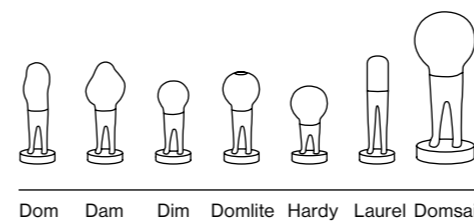











HOPEBIRD
Jaime Hayon

A-H40
A-H45

Scultura piccola/*Little sculpture*
Scultura grande/*Big sculpture*

33 × H 72 cm
57 × H 130 cm

13 × H 28.3 in
22.4 × H 51.2 in





D1



D2



D9



D10



D3



D4



D11



D12



D5



D6



D13



D14



D7



D8



D15



D16



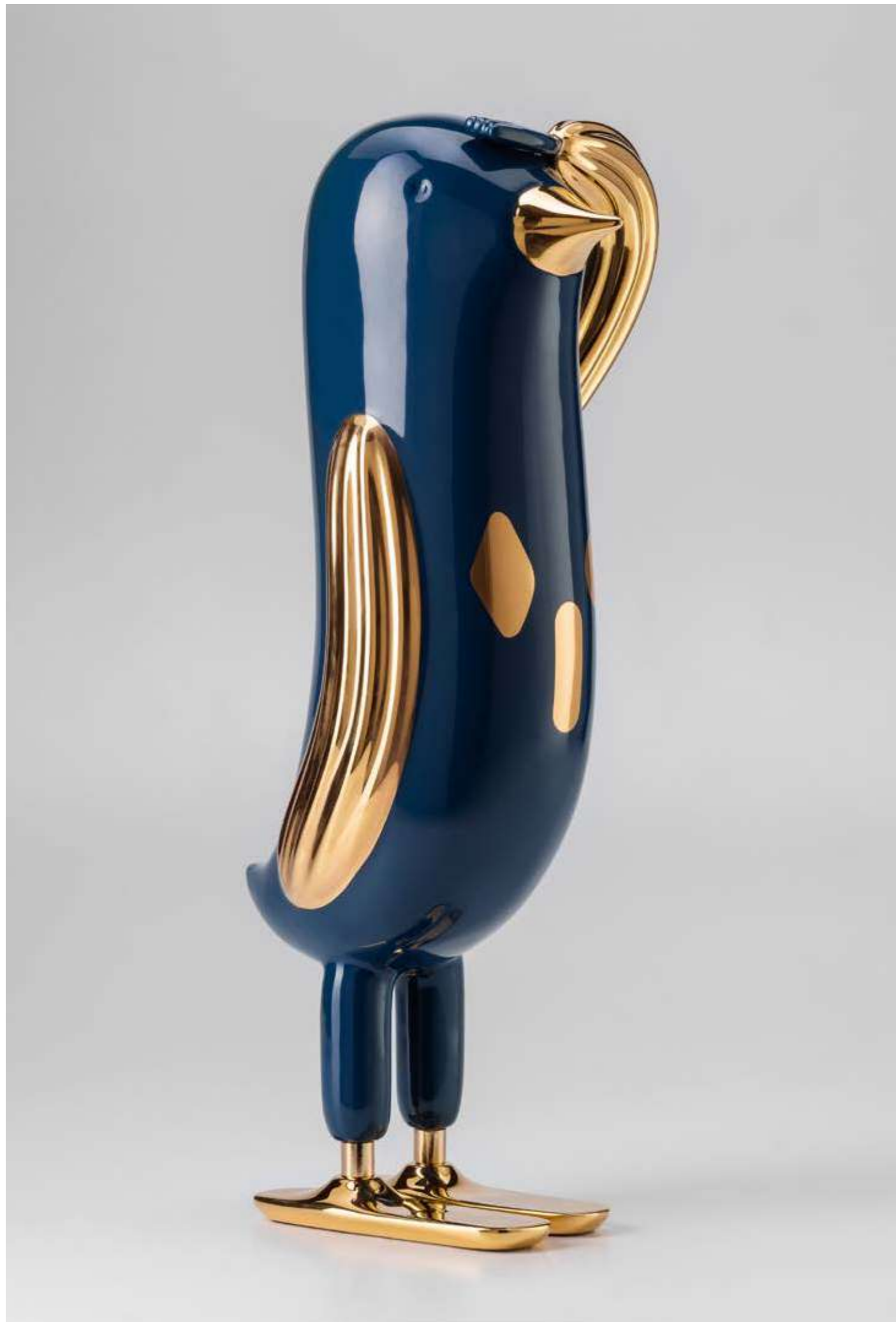





MASKHAYON
Jaime Hayon

A-H46	Orso grande/ <i>Big bear</i>	57 × H 57 cm	22.5 × H 22.5 in
A-H47	Orso piccolo/ <i>Small bear</i>	37 × H 38 cm	14.6 × H 15 in
A-H48	Elefante grande/ <i>Big elephant</i>	32,5 × H 45 cm	12.8 × H 17.7 in
A-H49	Elefante piccolo/ <i>Small elephant</i>	25,5 × H 35 cm	10 × H 13.8 in
A-H50	Scimmia grande/ <i>Big monkey</i>	50 × H 53 cm	20 × H 20.9 in
A-H51	Scimmia piccola/ <i>Small monkey</i>	33 × H 35 cm	13 × H 13.8 in













COMPAGNO BIRD
Sebastian Herkner

A/12/BI/L
A/12/BI

Grande/*Big*
Piccolo/*Small*

11 × H 16 cm
4 × H 6 cm

4.3 × H 6.3 in
1.6 × H 2.4 in





MOMONSTER
Giovanni Motta

GM/BLUEJULIAN	Blue Julian/Scultura/Sculpture	32 × H30 cm	12.6 × H 11.8 in
GM/REDATOMIC	Red Atomic/Scultura/Sculpture	16 × H30 cm	6.3 × H 11.8 in
GM/01	Nine Plus/Scultura/Sculpture	30 × H42 cm	11.8 × H 16.5 in
GM/02	Sweet Coke/Scultura/Sculpture	20 × H32 cm	7.9 × H 12.6 in
GM/03	Blue Chute/Scultura/Sculpture	19 × H23 cm	7.5 × H 9.1 in
GM/04	Pollux/Scultura/Sculpture	18 × H23 cm	7.1 × H 9.1 in
GM/05	Was an Egg/Scultura/Sculpture	18 × H24 cm	7.1 × H 9.4 in
GM/06	The Part of Zucchini/Scultura/Sculpture	22 × H24 cm	8.7 × H 9.4 in

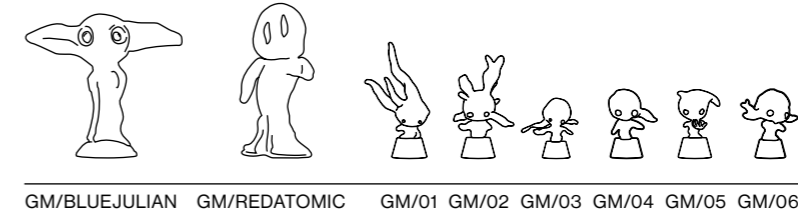



← Little Indians
→ Blue Black
↓ Toowomba



PRIMATES MASK
Elena Salmistraro

A/20/M	Mandrillus mask/Maschera/Mask	30 × 12 × H38 cm	11.8 × 4.7 × H 15 in
A/21/M	Brazza mask/Maschera/Mask	27 × 12 × H38 cm	10.6 × 4.7 × H 15 in
A/22/M	Kandti mask/Maschera/Mask	30 × 12 × H38 cm	11.8 × 4.7 × H 15 in



↖ Mandrillus
→ Kandti
↑ Brazza





BERNARDO
Elena Salmistraro

A/23 Scultura/Sculpture 27 × H48 cm 10.6 × H18.9 in







MI/01 MI/02 MI/03 MI/04

MOST ILLUSTRIOUS
Elena Salmistraro

MI/01	Achille/Scultura/Sculpture	13 × 11 × H 32 cm	5.1 × 4.3 × H 12.6 in
MI/02	Riccardo/Scultura/Sculpture	13 × 14 × H 35 cm	5.1 × 5.5 × H 13.8 in
MI/03	Michele/Scultura/Sculpture	16 × 13 × H 36 cm	6.3 × 5.1 × H 14.2 in
MI/04	Alessandro/Scultura/Sculpture	13 × 9,5 × H 29 cm	5.1 × 3.7 × H 11.4 in





↑ Furlo
↗ Carmelo
→ Armando



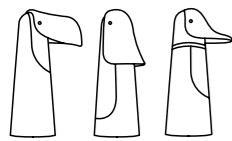

A/13 A/14 A/15

BEC
Ionna Vautrin

A/13	Tucano scultura/ <i>Toucan sculpture</i>	26 × 16 × H 45 cm	10.2 × 6.3 × H 17.7 in
A/14	Gabbiano scultura/ <i>Seagull sculpture</i>	18 × 16 × H 45 cm	7.1 × 6.3 × H 17.7 in
A/15	Papero scultura/ <i>Duck sculpture</i>	23 × 16 × H 45 cm	9.1 × 6.3 × H 17.7 in







LUCI

LIGHTS

LAMPADE
DA TAVOLO

TABLE LAMPS

298

PIANTANE
E SOSPENSIONI

FLOOR AND
HANGING LAMPS

316

LAMPADE DA TAVOLO
TABLE LAMP

SILK
Enrico Azzimonti
— 302

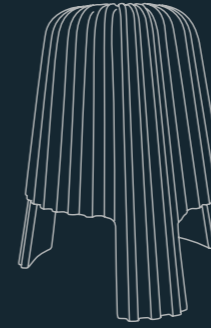

CHAMPAGNE À DEUX
Sam Baron
— 304



DOMLIGHT
Matteo Cibic
— 306

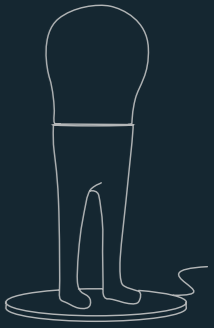

BUBBLES LAMP
Jaime Hayon
— 308



JELLY
Marc Sadler
— 310

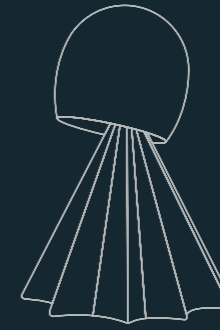

KINA
Marco Zito
— 314

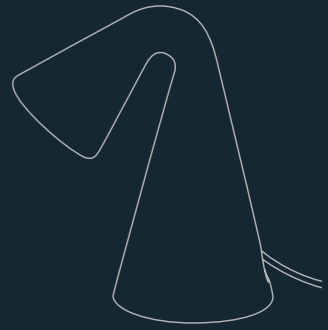

PIANTANE E SOSPENSIONI
FLOOR AND HANGING TABLE

SASSI LUMINOSI
Daniele Piazzi
— 320

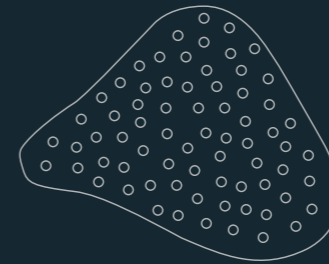

NOTTE BIZANTINA
Daniele Piazzi
— 322

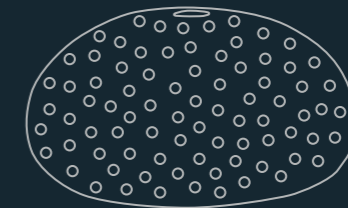

TRUMPET
Matteo Zorzenoni
— 326

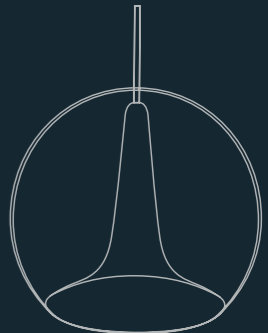



TABLE LAMPS

LAMPADARE DA TAVOLO

SILK	Enrico Azzimonti	302
CHAMPAGNE À DEUX	Sam Baron	304
DOMLIGHT	Matteo Cibic	306
BUBBLES LAMP	Jaime Hayon	308
JELLY	Marc Sadler	310
KINA	Marco Zito	314





U/1375	Lampada da tavolo (3 bottiglie)/ <i>Table lamp (3 bottles)</i>	30 × 12 × H 60 cm	11.8 × 4.7 × H 23.6 in
U/1376	Lampada da tavolo (2 bottiglie)/ <i>Table lamp (2 bottles)</i>	30 × 20 × H 88 cm	11.8 × 7.9 × H 34.6 in







BUBBLES LAMP
Jaime Hayon

A-H08 Lampada da tavolo / *Table lamp* 33 × H62 cm 13 × H24.4 in









FLOOR AND HANGING LAMPS

PIANTANE SOSPENSIONI

SASSI LUMINOSI	Daniele Pianezzola	320
NOTTE BIZANTINA		322
TRUMPET	Matteo Zorzenoni	326

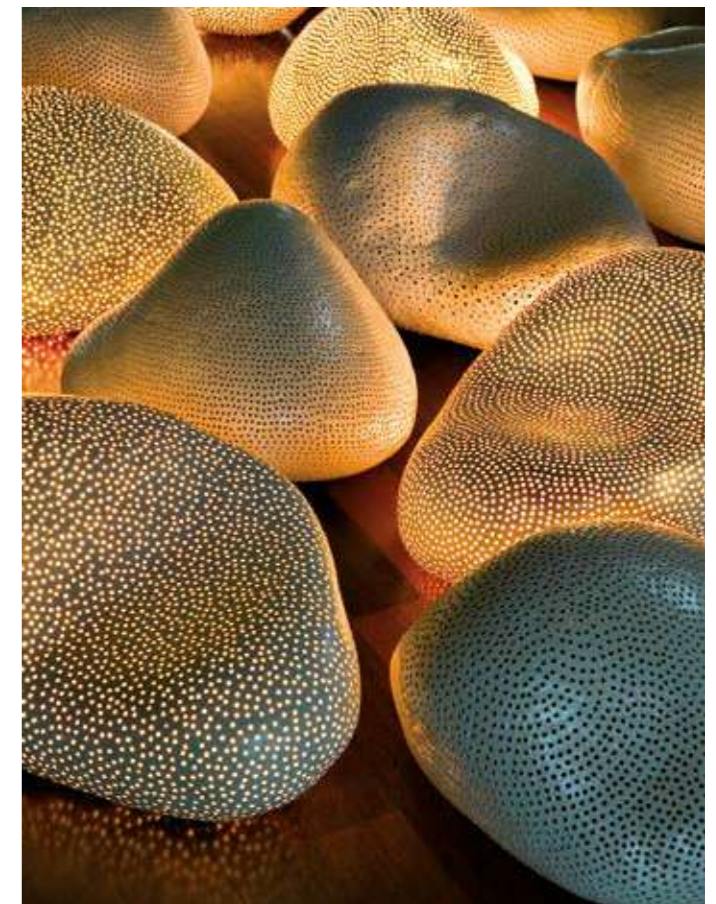

SASSILUMINOSI
Daniele Pianezzola

1508
1509

Lampada grande/*Big lamp*
Lampada piccola/*Small lamp*

68 × 42 × H 30 cm
48 × 48 × H 30 cm

26.8 × 16.5 × H 11.8 in
18.9 × 18.9 × H 11.8 in









TAVOLA

TABELEWARE

TAZZE	CUPS	334
PIATTI	PLATES	352
BROCCHIE	DECANTERS	366
VASSOI	TRAYS	378
ACCESSORI	ACCESSORIES	388

**TAZZE
CUPS**

NATURAL LEAF
Francesca e Italo Bosa
—338

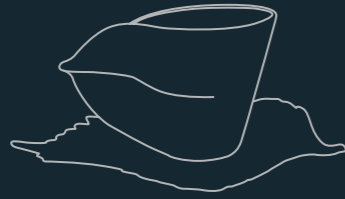

**HAY ON TABLE
COLLECTION**
Jaime Hayon
—340



THEATRE HAYON
Jaime Hayon
—342



PELLICANO
Jaime Hayon
—372



CUBO BIBITA
Riccardo Schweizer
—374

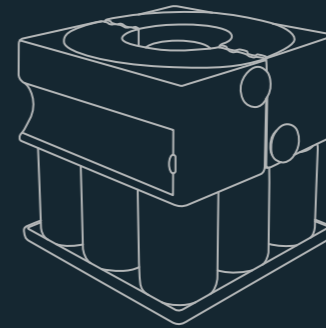

BROCCA H2O
Patricia Urquiola
—376

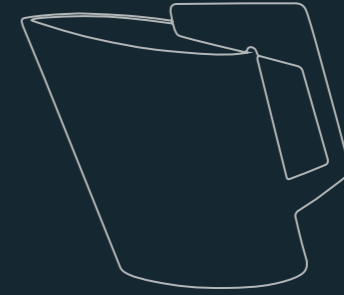

VELA
Luca Nichetto
—344

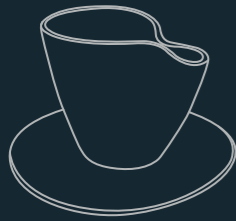

COFFEE CUP M
Studio Minotti
—346

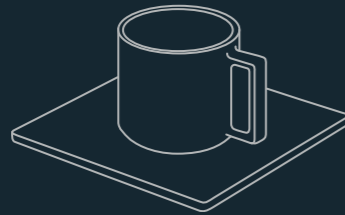

ESCAMAS
Elena Salmistraro
—348

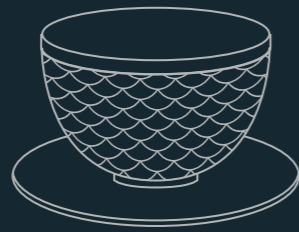

WARM-UG
Joeyelluto
—350



**VASSOI
TRAYS**

...ISSIMA!
Sam Baron
—382

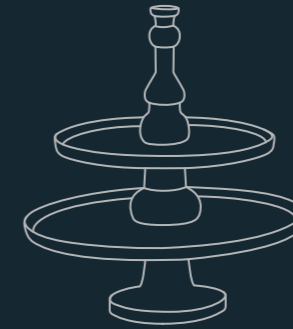

GOG
Francesca Bosa
—384

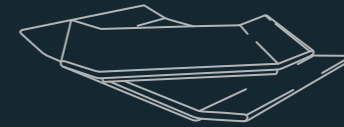

LIBELLULA
Francesca Bosa
—386

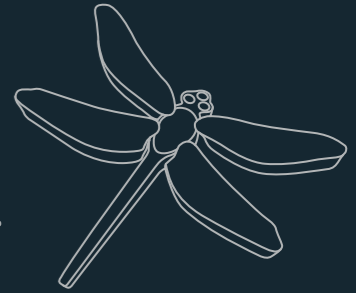

**PIATTI
PLATES**

SLICES OF DESIGN
Sam Baron
—356

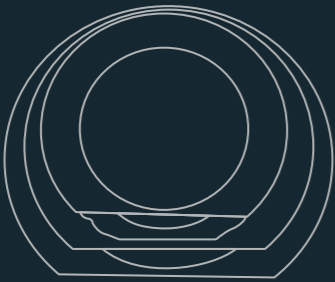

NATURAL LEAF
Francesca e Italo Bosa
—358



**HAY ON TABLE
COLLECTION**
Jaime Hayon
—360

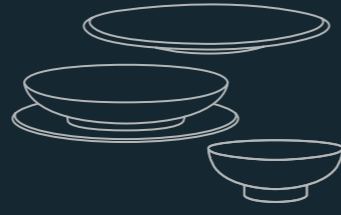

**ACCESSORI
ACCESSORIES**

2BALLS
Francesca Bosa
—390



TWINS
Gordon Guillaumier
—392



SALT AND PEPPER
Jaime Hayon
—394

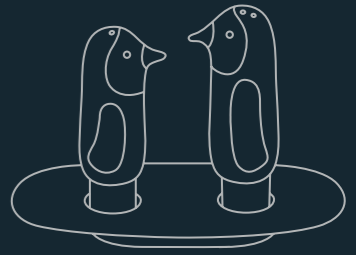

GIULIETTA E ROMEO
Riccardo Schweizer
—364

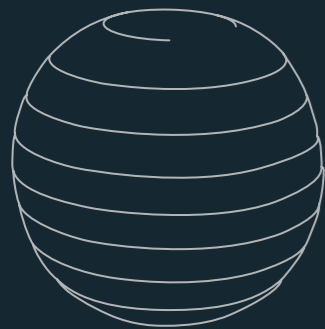

**BROCCHIE
DECANTERS**



CALLA
Manolo Bossi
—368

DECANTER
Jaime Hayon
—370





NATURAL LEAF	Francesca e Italo Bosa	338
HAYON TABLE COLLECTION	Jaime Hayon	340
THEATREHAYON		342
VELA	Luca Nichetto	344
COFFEE CUP M	Studio Minotti	346
ESCAMAS	Elena Salmistraro	348
WARM-UG	Joevelluto	350



NATURAL LEAF
Francesca e Italo Bosa

U/1417	Tazza/Cup	12 × 12 × H8 cm	4.7 × 4.7 × H3.1 in
U/1418	Piattino/Saucer	21 × 16 × H2,5 cm	8.3 × 6.3 × H1 in





**HAYON TABLE
COLLECTION**
Jaime Hayon

A-H56	Tazza The/Tea cup	11 × H9 cm	4.3 × H3.5 in
A-H57	Tazza caffè/Coffee cup	10 × H8 cm	3.9 × H3.1 in
A-H58	Tazza orzo/White coffee cup	11 × H5 cm	4.3 × H2 in
A-H65	Bicchiere/Glass	10 × H8 cm	3.9 × H3.1 in
A-H56/P	Piattino per tazze/Saucer	12,5 × H1,5 cm	4.9 × H0.6 in







U/1355 Tazza da caffè con piattino/*Coffee cup with saucer*

Tazza/*Cup*

Piattino/*Saucer*

6 × H 6 cm

2.4 × H 2.4 in

12 × 12 × H 0,8 cm

4.7 × 4.7 × H 0.3 in

U/1354 Tazza da tè con piattino/*Tea cup with saucer*

Tazza/*Cup*

Piattino/*Saucer*

10 × H 4,7 cm

3.9 × H 1.9 in

15 × 15 × H 0,8 cm

5.9 × 5.9 × H 0.3 in



ESCAMAS
Elena Salmistraro

1820	Kora/Tazza/Cup	15 × H 11 cm	5.9 × H 4.3 in
	Piattino/Saucer	20,5 × H 2 cm	8.1 × H 0.8 in
1821	Rabat/Tazza/Cup	15 × H 11 cm	5.9 × H 4.3 in
	Piattino/Saucer	20,5 × H 2 cm	8.1 × H 0.8 in



↑ Kora
→ Rabat





PLATES

PIATTI

SLICES OF DESIGN	Sam Baron	356
NATURAL LEAF	Francesca e Italo Bosa	358
HAYON TABLE COLLECTION	Jaime Hayon	360
GIULIETTA E ROMEO	Riccardo Schweizer	364



SLICES OF DESIGN
Sam Baron

T105	Set di piatti/ <i>Set of plates:</i>		
	T100 Piatto zuppa/ <i>Soup plate</i>	21 × H3 cm	8.3 × H1.2 in
	T101 Piatto/ <i>Plate</i>	28 × H1,5 cm	11 × H0.6 in
	T102 Piatto/ <i>Plate</i>	32 × H1,5 cm	12.6 × H0.6 in
	T103 Piatto antico/ <i>Antique plate</i>	22 × H1,5 cm	8.7 × H0.6 in
	T104 Piatto frutta/ <i>Fruit plate</i>	22 × H1,5 cm	8.7 × H0.6 in
T106	Piatto da portata/ <i>Dish</i>	45 × 35 × H5 cm	17.7 × 13.8 × H2 in
T107	Insalatiera/ <i>Salad bowl</i>	27 × H9 cm	10.6 × H3.5 in



NATURAL LEAF
Francesca e Italo Bosa

U1410	Set di piatti/ <i>Set of plates:</i>		
	U1411 Sottopiatto/ <i>Under plate</i>	33 × 33 × H 0,5 cm	13 × 13 × H 0.2 in
	U1412 Piatto/ <i>Plate</i>	31 × 32 × H 1,5 cm	12.2 × 12.6 × H 0.6 in
	U1420 Piatto zuppa/ <i>Soup plate</i>	24 × 24 × H 4,5 cm	9.4 × 9.4 × H 1.8 in
	U1415 Piatto frutta/ <i>Fruit plate</i>	19 × 18 × H 1 cm	7.5 × 7.1 × H 0.4 in
U1413	Piatto/ <i>Plate</i>	27 × 28 × H 1,5 cm	10.6 × 11 × H 0.6 in
U1414	Piatto zuppa/ <i>Soup plate</i>	20 × 20 × H 4 cm	7.9 × 7.9 × H 1.6 in
U1419	Piatto/ <i>Plate</i>	24 × 25 × H 1,5 cm	9.4 × 9.8 × H 0.6 in
U1416	Ciotola/ <i>Salad bowl</i>	25 × 24 × H 18 cm	9.8 × 9.4 × H 7.1 in



**HAYON TABLE
COLLECTION**
Jaime Hayon

A-H55/P1	Piatto Piano/ <i>Plate</i>	27 × H 1,5 cm	10.6 × H 0.6 in
A-H55/P2	Piatto Zuppa/ <i>Soup plate</i>	23 × H 3,5 cm	9.1 × H 1.4 in
A-H55/P3	Piattino/ <i>Fruit plate</i>	21 × H 1,5 cm	8.3 × H 0.6 in
A-H59	Ciotola grande/ <i>Big bowl</i>	24 × H 11 cm	9.5 × H 4.3 in
A-H60	Ciotola media/ <i>Medium bowl</i>	15,5 × H 5 cm	6.1 × H 2 in
A-H61	Ciotola piccola/ <i>Small bowl</i>	12 × H 7 cm	4.7 × H 2.8 in







GIULIETTA ROMEO RS02 Set di piatti per 2 persone/Set of plates for 2 people 23 x H23 cm 9.1 x H9.1 in
Riccardo Schweizer

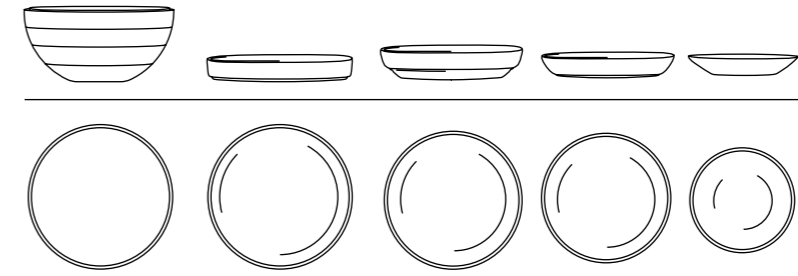

DECANTERS

BROCCHE

CALLA	Manolo Bossi	368
DECANTER PELLICANO	Jaime Hayon	370 372
CUBO BIBITA	Riccardo Schweizer	374
BROCCA H2O	Patricia Urquiola	376

CALLA
Manolo Bossi

U/1363
U/1359

Brocca grande/*Big decanter*
Brocca piccola/*Small decanter*

13 × 16 × H28 cm
13 × 11 × H26 cm

5.1 × 6.3 × H 11 in
5.1 × 4.3 × H 10.2 in



DECANTER
Jaime Hayon

A-H62 Brocca/Decanter 18 x H20 cm 7.1 x H7.9 in







CUBOBIBITA
Riccardo Schweizer

RS03 Set di 2 brocche e 10 bicchieri/Set of 2 decanters and 10 glasses 21×21×H22 cm 8.3×8.3×H8.7 in





TRAYS

VASSOI

...ISSIMA!	Sam Baron	382
GOG	Francesca Bosa	384
LIBELLULA		386



SB/118	Alzata grande/ <i>Big table decoration</i>	32,5 × H 37 cm	12.8 × H 14.6 in
SB/119	Alzata media/ <i>Medium table decoration</i>	25 × H 30 cm	9.8 × H 11.8 in
SB/120	Alzata piccola/ <i>Small table decoration</i>	25 × H 18 cm	9.8 × H 7.1 in





LIBELLULA
Francesca Bosa

U/1395 Antipastiera/Hors d'oeuvre dish 45 × 58 × H5 cm 17.7 × 22.8 × H2 in



ACCESSORIES

ACCESSORI

2BALLS	Francesca Bosa	390
TWINS	Gordon Guillaumier	392
SALT AND PEPPER	Jaime Hayon	394







SURFACES

COCOA
CANYON

Elena Salmistraro

398
400

SUPERFICI

TILE1	Cocoa intera/Cocoa tile	27,5 × 15 × H1,2 cm	10.8 × 5.9 × H0.5 in
	Elemento laterale/Side element	27,5 × 7,5 × H1,2 cm	10.8 × 3 × H0.5 in
	Elemento base/Base element	15 × 15 × H1,2 cm	5.9 × 5.9 × H0.5 in
TILE1/MQ		105 × 110 cm	41.3 × 43.3 in





CANYON
Elena Salmistraro

TILE2

Canyon intera/Canyon tile
Elemento laterale/Side element
Elemento base/Base element

20,5 × 20,5 × H3 cm
6,5 × 16 × H3 cm
20 × 13 × H3 cm
97 × 97 cm

8.1 × 8.1 × H1.2 in
2.6 × 6.3 × H1.2 in
7.9 × 5.1 × H1.2 in
38.2 × H38.2 in



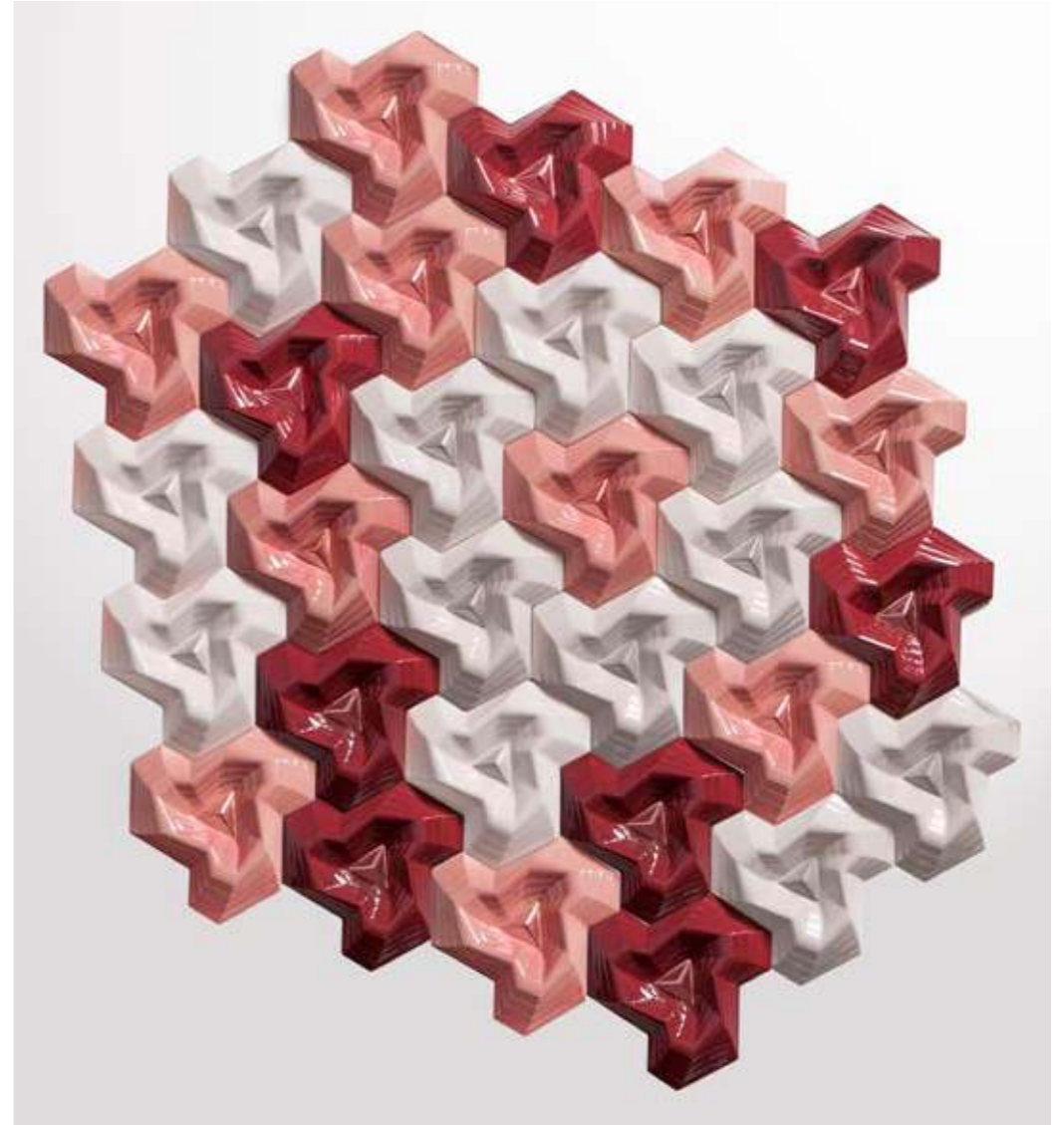
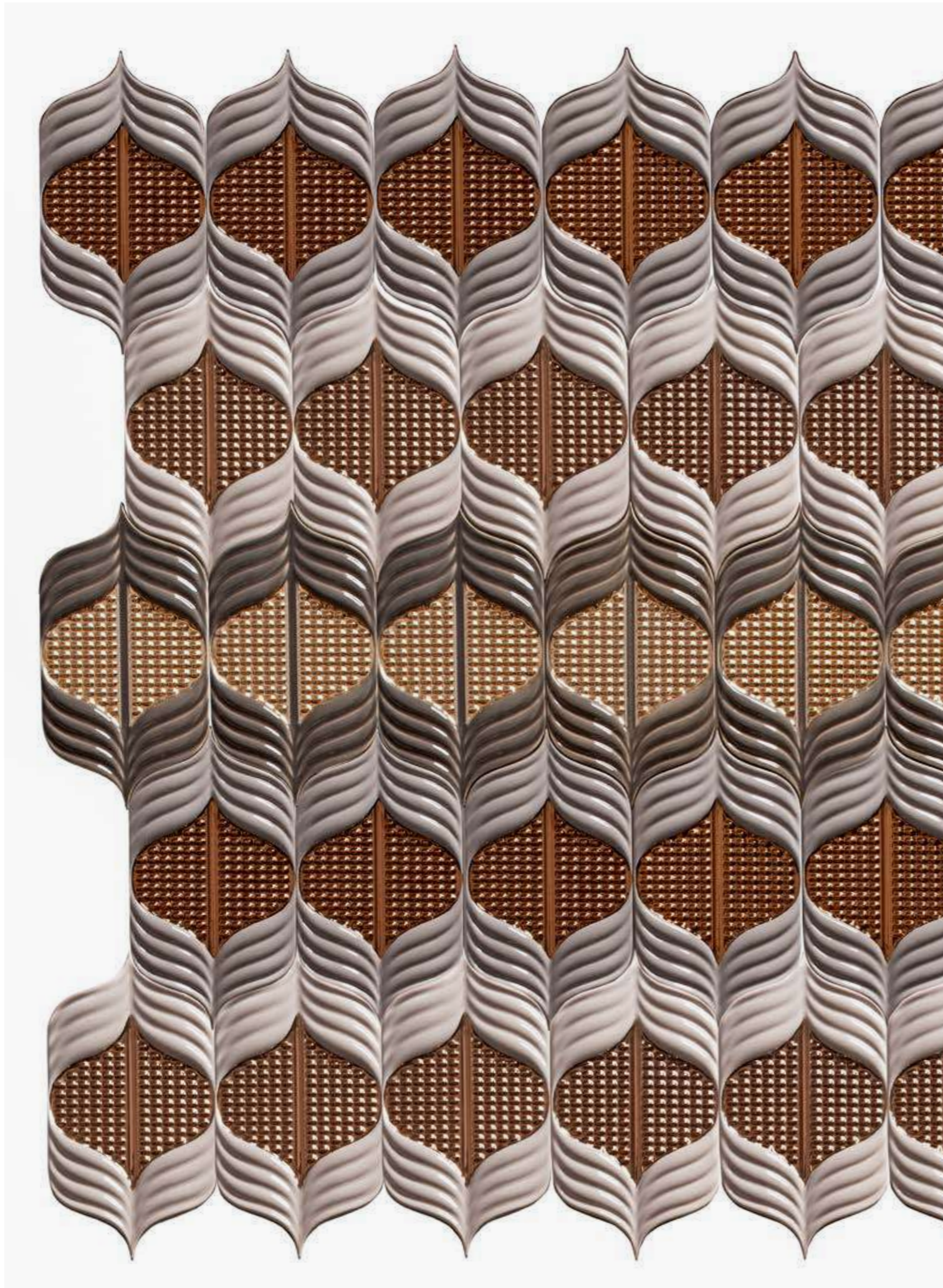

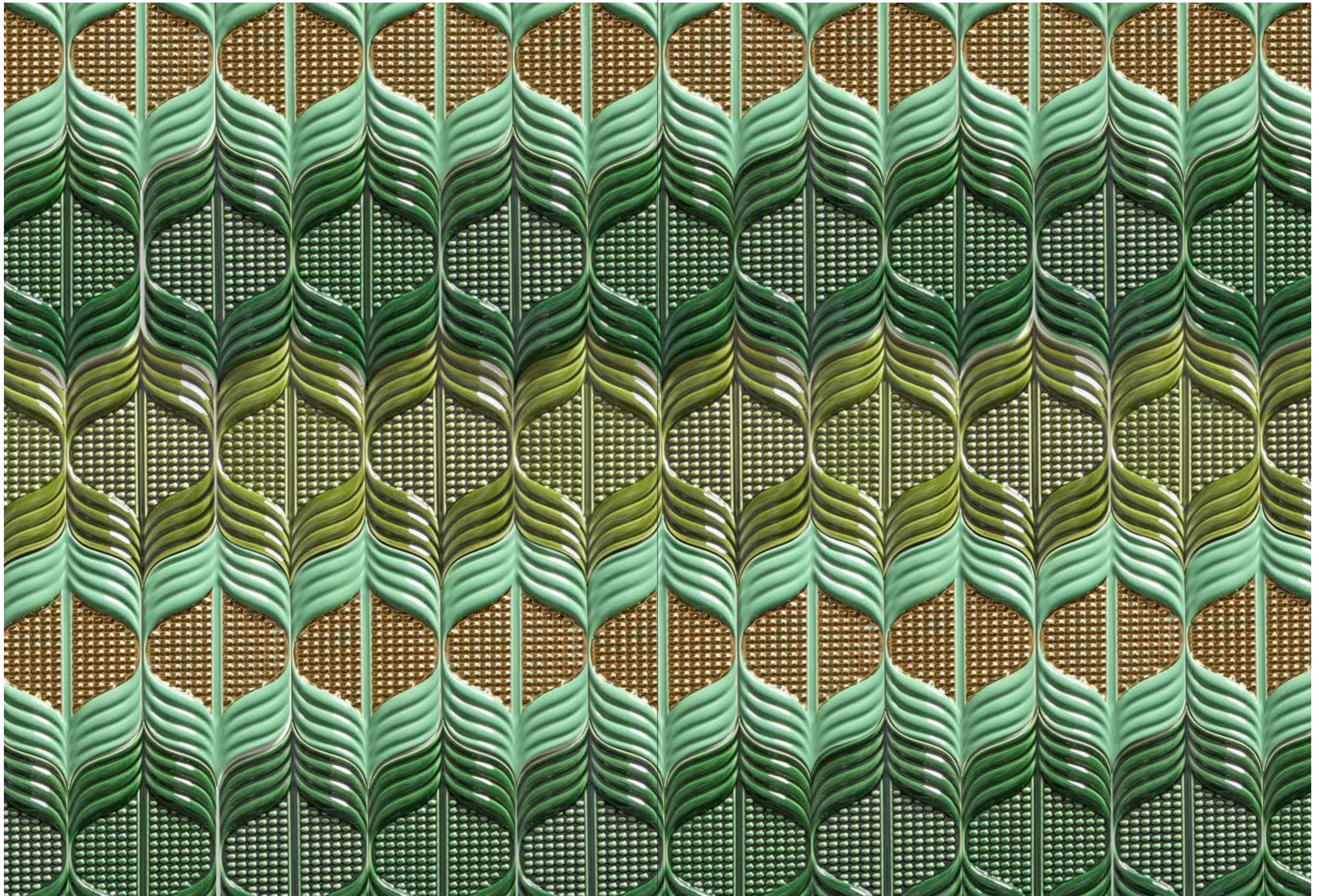

A

Enrico Azzimonti Silk —302 

B

Sam Baron Isole —28  ...Issima! —30  ...Issima! —32 

...Issima! —34  Venus —36  ...Issima! —130  ...Issima! —154  ...Issima3! —156  ...Issima! —157  Ariete, Toro, Unicornio —216  Champagne à deux —304 





Slices of design —356  ...Issima! —382  **Matteo Bianchi** Vasilly —218  Mr. James —219  **Studio Bordo** Scacchiera —194 

Francesca Bosa Paire —38  Move —40  V-Groove —40  Roller —40  Ball —42  Baloo —44  Shell —98 

Rouleau —132  Gudo —134  Don't be too square —196  Don't be too square —196  Thin Bowl —198  Sphere —220  Coralli —224  Natural Leaf —338 

Natural Leaf —358  GOG —384  Libellula —386  2Balls —390  **Italo Bosa** Bagus —46  Gabo —48  Fogliabanano —100 

Foglialiscia —104  Handcraft —106  Portafoto —200  Sassi —228  Natural Leaf —338  Natural Leaf —358  **Studio Bosa** Circle —50 

Manolo Bossi The owls —230  Calla —368  **C** **Matteo Cibic** Koni —204  Tolo, Pilo, Calo —234  Dogsai, Domsai —236 

Domlight —306  **Ciszak-Dalmas** Aura —192  **CtrlZak** Unlock —238  **G** **Vittorio Gennari** Dab Penguin —240 





Mr. Ciao —244  **Gordon Guillaumier** Habanos —202  Twins —392  **Constance Guisset** Fusca —52  Sweet souvenir —206 

H **Jaime Hayon** TheatreHayon —56  Stripy —62  Joya table —138  T-table —140  Atomo —158  Bubbles —160 

Canfino —162  Spring —164  TheatreHayon —166  Pinocchietto —168  Horamur —178  Fantasmiko —180  Hopebird —246  Clown —254 

MaskHayon —256  Duck elephant multivase —262  Horse —266  Bubbles lamp —308  Hayon table collection —340  TheatreHayon —342  Hayon table collection —360  Decanter —370 

Pellicano —372  Salt and pepper —394  **Sebastian Herkner** Compagno bird —268  **J** **Joevelluto** Warm-ug —108 

Marisa Fick Jordaan Amasumpa —108  **M** **Studio Minotti** Cut —66  Cut —110  Coffee cup M —346 

Sachiko Mizoguchi Treali —112  **Giovanni Motta** Momonster —270  **N** **Luca Nichetto** Umbravase —70  Vela —344 

P **Ludovica e Roberto Palomba** Oops —72  Cup —114  **Shay Frish Peri** Nadneda —74  **Daniele Pianezzola** Sassiluminosi —320 

Notte bizantina —322  **R** **Pepa Reverter** Sisters —76  Bossa Nova —146  Secret Love —208 

S	Gualtiero Sacchi 6x4 -170		Marc Sadler Jelly -310		Elena Salmistraro Primates -86		Primates -274								
	Primates Plates -276		Bernardo -278		Loricato, Khepri -280		Most Illustrious -282		IMolossi -284		Escamas -348		Cocoa -398		Canyon -400
Simona Sbordone	Hong Kong -120		Miami -122		Tokyo -124		Riccardo Schweizer	Giulietta e Romeo -364		Cubo bibita -372					
U	Patricia Urquiola	Brocca H2O -376		V	Ionna Vautrin	Bec -286		Mascotte -288							
	Alessandro Zambelli	Lume -172			Marco Zanuso jr.	Pomina -92		Hobart -116		Melrose -116					
Z	Marco Zito	Posa -182		Celo -184		Kina -314		Matteo Zorzenoni	Trumpet -326		Nadja Galli Zugaro e G. Grandi	Noah -118			
	Nika Zupanc	Infinity Clock -186		Magic Ball Box -210		Oh, baby, it is a wild world -290									

	COMPLEMENTI - FURNISHING	LUCI - LIGHTS	TAVOLA - TABLEWARE
Enrico Azzimonti		302	
Sam Baron	28, 130, 154, 216	304	356, 382
Matteo Bianchi	218		
Studio Bordò	194		
Francesca Bosa	38, 98, 132, 196, 220		338, 358, 384, 390
Italo Bosa	46, 100, 200, 228		338, 358
Studio Bosa	50		
Manolo Bossi	230		368
MatteoCibic	204, 234	306	
Ciszak-Dalmas	192		
CtrlZak	238		
VittorioGennari	240		
Gordon Guillaumier	202		392
Constance Guisset	52, 206		
Jaime Hayon	56, 138, 158, 178, 246	308	340, 360, 370, 394
Sebastian Herkner	268		
Joevelluto			108
Marisa Fick Jordaan	108		
Studio Minotti	66, 110		346
Sachiko Mizoguchi	112		
Giovanni Motta	270		
Luca Nichetto	70		344
Ludovica e Roberto Palomba	72, 114		
Shay Frish Peri	74		
Daniele Pianezzola		320	
Pepa Reverter	76, 146, 208		
Gualtiero Sacchi	170		
Marc Sadler		310	
Elena Salmistraro	86, 274		348
Simona Sbordone	120		
Riccardo Schweizer			364, 372
Patricia Urquiola			376
Ionna Vautrin	286		
Alessandro Zambelli	172		
Marco Zanuso jr.	92, 116		
Marco Zito	182		314
Matteo Zorzenoni		326	
Nadja Galli Zugaro e G. Grandi	118		
Nika Zupanc	186, 210, 290		

SMALTI
COLORATI LUCIDI/
COLORED
GLOSSY GLAZES

04. Bianco lucido/ Glossy white	02. Grigio chiaro lucido/Glossy light grey	27. Grigio sasso lucido/Glossy stone grey	52. Levriero lucido/ Glossy greyhound	12. Cashmere lucido/Glossy cashmere
03. Tortora lucido/ Glossy tortora	35. Grigio fumo lucido/Glossy smoke grey	30. Grigio caldo lucido/Glossy warm grey	55. Fango lucido/ Glossy brown mud	06. Caffè lucido/ Glossy coffee
98. Piombo lucido/ Glossy lead grey	09. Nero lucido/ Glossy Black	93. Orzo lucido/ Glossy barley	07. Giallo scuro lucido/Glossy dark yellow	24. Giallo limone lucido/Glossy lemon yellow
39. Ottanio lucido/ Glossy teal	75. Verde menta lucido/Glossy mint green	76. Verde bosco lucido/Glossy forest green	79. Verde pineta lucido/Glossy pinewood green	59. Lime lucido/ Glossy lime
77. Verde fieno lucido/Glossy hay green	73. Cachilucido/ Glossy khaki orange	74. Rosso acceso lucido/Glossy fire red	40. Bordeaux lucido/Glossy bordeaux	46. Rubino lucido/ Glossy ruby red
58. Ciclamino lucido/Glossy cyclamen	47. Rosasalmone lucido/Glossy salmon pink	22. Rosa baby lucido/Glossy baby pink	61. Grigio lilla lucido/ Glossy grey lilac	21. Rosa tea lucido/ Glossy tea pink
48. Violetto lucido/ Glossy purple	29. Ametista lucido/ Glossy amethyst	90. Sugar paper lucido/Glossy sugar paper	63. Latte e menta lucido/Glossy milk and mint	62. Acquamarina lucido/Glossy aquamarine
92. Biscay bay lucido/Glossy biscay bay	51. Blu ciano lucido/ Glossy cyan blue	96. Blu cobalto lucido/Glossy cobalt blue	49. Blu pavone lucido/Glossy peacock blue	95. Blu oltremare lucido/Glossy ultramarine blue

SMALTI
COLORATI OPACHI/
COLORED
MATT GLAZES

16. Bianco opaco/ Matt white	99. Grigio peltro opaco/Matt pewter grey	08. Nero opaco/ Matt black	26. Marrone opaco/ Matt brown	45. Ecrù opaco/ Matt ecru
38. Aloe opaco/ Matt aloe	19. Nero ferro opaco/ Matt iron black			
05. Bianconeve ruvido/Rough snow white	13. Lino ruvido/ Rough linen	28. Cemento ruvido/ Rough concrete	33. Grafite ruvido/ Rough graphite	70. Argilla ruvido/ Rough clay
50. Rosa vintage ruvido/Rough vintage pink	78. Glicine ruvido/ Rough wisteria	86. Indaco ruvido/ Rough indigo	11. Azzurro polvere ruvido/Rough powder blue	88. Blue jeans ruvido/Rough blue jeans
34. Ottanio ruvido/ Rough teal	20. Inchiostro ruvido/ Rough ink blue	17. Senaperuvido/ Rough mustard		
04/29. Oro lucido/ Glossy gold	04/92. Oro rosa lucido/Glossy pink gold	04/84. Oro antico lucido/ Glossy old gold	04/83. Oro verde lucido/ Glossy green gold	04/80. Rame lucido/ Glossy copper
04/91. Bronzo lucido/ Glossy bronze	04/63. Platino lucido/ Glossy platinum	04/85. Platino scuro lucido/Glossy dark platinum		
16/29. Oro opaco/ Matt gold	16/92. Oro rosa opaco/Matt pink gold	16/84. Oro antico opaco/ Matt old gold	16/83. Oro verde opaco/ Matt green gold	16/80. Rame opaco/ Matt copper
16/91. Bronzo opaco/Matt bronze	16/63. Platino opaco/Matt platinum	16/85. Platino scuro opaco/Matt dark platinum		

Concept and
graphic design
Metodo studio
(Paolo Palma,
Alessio Romandini)

Communication
consultant
Umbrella

Printing
Grafiche Antiga,
Crocetta (TV)

Photo
Frank Juery
Martin Fogaça
Alberto Parise
Tiziano Rossi
Riccardo Urnato
Tom Vack
Cristina Vaquero

Thanks to
Linda Perini, El Studio
Fabrika, Trio
Studio Hayon

Tutti i prodotti del catalogo possono essere richiesti con le tonalità presenti nella scheda colori, il tono esatto dello smalto va però verificato con il campionario colori in ceramica. Nei diversi oggetti la stessa tonalità potrà riportare piccole differenze di intensità del colore, soprattutto legate a forme e volumi differenti o dovute a variazioni minime della temperatura di cottura. Sono queste diverse caratteristiche che rendono unico ogni pezzo.

All the products in the catalogue may be ordered in the hues shown in the colour sheet, though the exact tone of the glaze must be verified against the ceramic colour samples. In different objects, the same hue may show slight differences in the intensity of the colour, caused generally by the different shapes and volumes, or due to minimum variations in firing temperature. These distinct characteristics contribute to making each piece unique.

I nuovi prodotti possono essere soggetti a modifiche nelle specifiche, dimensioni e finiture a causa di sviluppi produttivi. Tutti i disegni mostrati sono protetti da copyright. Bosa detiene i diritti di produrre e vendere questi prodotti nonché l'esclusiva per la produzione e distribuzione in tutto il mondo. La copia sarà perseguita secondo la legge.

New products may be subjected to minor changes in specifications, size and finish due to production developments. All the designs shown here are protected under copyright law. Bosa has the property rights to manufacture and sell these products and holds the exclusive manufacturing and distribution rights worldwide. Copying will be prosecuted.

BOSA

Direzione Generale
Via Molini, 44
31030 Borso del Grappa
Treviso - IT

Tel +39 0423 561483
Fax +39 0423 542200
info@bosatrade.com
www.bosatrade.com

Follow us



@bosaceramiche

